

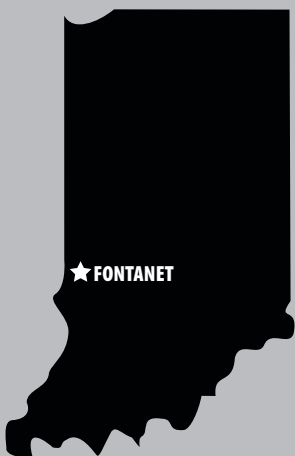

GREENLEAF
INCORPORATED

THE FLUID FLOW EXPERTS

Celebrating 40 Years!



**of Family Owned,
American Made
Products**

TABLE OF CONTENTS

Ball Valves

<i>Bolted Polypropylene Ball Valves</i>	
4 Bolt	4
6 Bolt	4
8 Bolt	4
3-Way Valve	5
Angle Valve	6
Single Union	6
HM	6
True Union	7
Dry Proppet	8

Couplers

GatorLock	10
Camlock	11-12
300200 Series	13
Garden Hose Couplings	13
Angled Camlocks	14
Shims & Replacement Gaskets	14

Bulkhead Fittings 15

Bolted Tank Fittings 15

Strainers 16

Schedule 80 - Heavy Duty

Straight Adapter	18
90° Hose Barb	18
Straight Hose Mender	18
Nipple	18
Reducing Coupling	19
Reducing Nipple	18
Elbow	19
Coupling	19
Street Elbow	19
Reducer Bushing	19
Tee w Gauge Port	20
Tee	20
Plug	20
Pipe Caps	20
Steel Hose Adapters	20
Pin Lug Couplers	20

Clamps 21-22

Fittings - Nylon & Polypropylene

Hose Fittings	24-27
Pipe Fittings	28-30
Garden Hose Fittings	31-33
Nozzle Fittings	34-35

Spray Components

Gauges	37
Boom Clamps	37
Nozzle Bodies	38-39
Winged Bayonet Caps	40
Spray Tips Filters	40
Solenoid Valves	41
Wiring Harnesses	41
Suction Filter	42
Hose Drop	42
Spray Wands	42

Rope Wick

String Wing & Mounts	43
Rope Wick Fittings	44
Rope Wick Kits	44
Weed Thief	44

Packaging & Merchandising 45



Ball Valves

Selection

Green Leaf valves are available in sizes ranging from 1/2" to 4".

Quality

Our primary resin is a high strength custom blended glass filled polypropylene.

Location

Green Leaf takes pride in the fact that most of our valves are made on site at our Indiana manufacturing location.

Experience

We have been producing high quality ball valves over 2 decades.

Variety

We have a variety of styles and configurations.

Choose from pipe threaded valves, garden hose valves, BSP valves, full port, standard port, and many more.

Custom

Can't find what you're looking for in our standard valve line? No worries, we make custom valves as well!

Knowledge

Let us use our expertise to help you make the right choice.



	PART #	PRICE ea.	DESCRIPTION	MAX. PSI
	V050FP	\$41.18	1/2" Female NPT x 1/2" Female NPT 1/2" opening thru ball	150
	V075FP	\$41.18	3/4" Female NPT x 3/4" Female NPT 3/4" opening thru ball	150
	V100FP	\$45.40	1" Female NPT x 1" Female NPT 1" opening thru ball	150
	V125FP	\$56.50	1-1/4" Female NPT x 1-1/4" Female NPT 1-1/4" opening thru ball	150
	V150FP	\$56.50	1-1/2" Female NPT x 1-1/2" Female NPT 1-1/2" opening thru ball	150
	V200	\$56.50	2" Female NPT x 2" Female NPT 1-1/2" opening thru ball	150
	V204FP	\$75.43	2" Female NPT x 2" Female NPT 2" opening thru ball	100
	V200FP	\$79.57	2" Female NPT x 2" Female NPT 2" opening thru ball	100
	V300	\$127.94	3" Female NPT x 3" Female NPT 2-1/2" opening thru ball	100
	V300FP	\$177.68	3" Female NPT x 3" Female NPT 3" opening thru ball	100
	V400FP	\$335.27	4" Female NPT x 4" Female NPT 4" opening thru ball	100
	VF204FP	\$84.32	2" Female NPT x 2" Male Adapter 2" opening thru ball	100
	VFMT204FP	\$84.32	2" Male NPT x 2" Male Adapter 2" opening thru ball	100
	VMT204FP	\$84.32	2" Female NPT x 2" Male NPT 2" opening thru ball	100
	VMM204FP	\$84.32	2" Male NPT x 2" Male NPT 2" opening thru ball	100

Bolted Ball Valve features:

- Stainless Steel Bolts
- Precision molded in polypropylene.
- Polypropylene is reinforced with fiberglass for additional strength. Self-aligning ball moves freely against the Teflon® seats for smooth operation. The valve opens and closes with little pressure on the handle.
- Ball is diamond turned, after molding, to make it spherically perfect, which provides precise contact between ball and seats.
- Viton® "O" rings.
- Teflon® self-lubricating stem bushings and seats cannot stick or bind.



NEW



3 Way Valve features:

- Sturdy Construction, fiberglass reinforced polypropylene body
- PTFE seats for smooth operation
- E.P.D.M. seals standard
- 125 P.S.I. @ 140° F

3 Way Valve

	PART #	PRICE ea.	DESCRIPTION
NEW	SU050BL	\$33.53	1/2" Female NPT
NEW	SU075BL	\$37.96	3/4" Female NPT
NEW	SU100BL	\$38.21	1" Female NPT
NEW	SU125BL	\$54.18	1 1/4" Female NPT
NEW	SU150BL	\$63.55	1 1/2" Female NPT
NEW	SU200BL	\$79.23	2" Female NPT

NEW



V25270 Straight Mounting Bracket

V25271 90° Mounting Bracket

Valve Mounting Plates feature:

- 304 Stainless Steel construction
- Fits V125FP, V150, V200, V300, V300FP

	PART #	PRICE ea.	DESCRIPTION
NEW	V25270	\$19.21	Straight Mounting Bracket
NEW	V25271	\$21.87	90° Mounting Bracket



Valve - Replacement Handles

PART #	PRICE ea.	DESCRIPTION
V20153	\$9.17	Handle Straight - 4 Bolt Series
V25153	\$14.96	Handle Straight - 6 Bolt Series
V20154	\$14.96	Handle Straight - 8 Bolt Series



Angle Valve

PART#	DESCRIPTION	PRICE ea.
VA204FP	2" Full Port — 100 PSI	\$97.85

Angle Valve features:

- One quarter turn polypropylene ball valve
- Used in liquid plumbing application as a quick shut off valve
- 100 P.S.I. @ 70° F

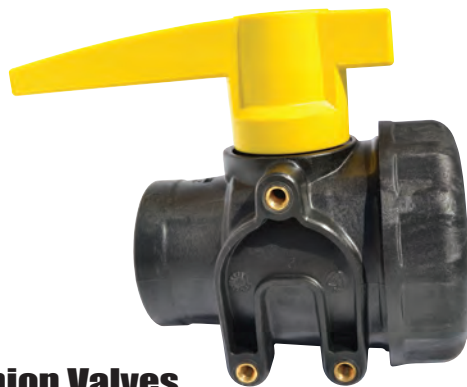

Single Union Valves

PART #	PRICE ea.	DESCRIPTION
SU050E	\$21.04	1/2" Female NPT
SU075E	\$21.04	3/4" Female NPT
SU100E	\$25.46	1" Female NPT
SU125E	\$43.72	1 1/4" Female NPT
SU150E	\$44.87	1 1/2" Female NPT
SU200E	\$56.96	2" Female NPT

Single Union Valve features:

- Sturdy Construction, fiberglass reinforced polypropylene body
- PTFE seats for smooth operation
- E.P.D.M. seals standard
- 125 P.S.I. @ 140° F

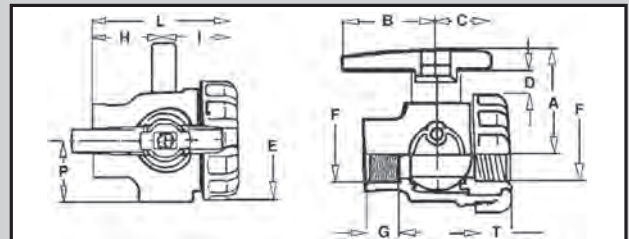

F/F NPT Threads (F)	Type	Dimensions (Inches)										
		A	B	C	D	E	G	H	I	L	P	T
1/2"		2.36	1.65	1.65	0.63	2.32	0.91	1.71	1.75	3.46		0.91
3/4"		2.36	1.65	1.65	0.63	2.32	0.91	1.71	1.75	3.46		0.91
1"	1	2.87	1.65	2.09	0.79	2.72	0.91	1.83	2.05	3.88	1.46	0.98
1 1/4"	1	3.15	1.65	3.03	0.79	3.23	0.98	2.11	2.17	4.27	1.69	1.02
1 1/2"	2	3.43	1.93	3.15	0.79	3.90	1.10	2.46	2.50	4.96	2.01	1.10
2"	2	4.33	1.93	5.12	0.98	4.53	1.18	2.87	2.97	5.85	2.01	1.18



HM Quick Shut Off Valve

PART #	PRICE ea.	DESCRIPTION
HM50B	\$14.54	1/2" Female NPT With Buna "O" Ring
HM75B	\$14.54	3/4" Female NPT With Buna "O" Ring
HM50V	\$15.21	1/2" Female NPT With Viton® "O" Ring
HM75V	\$15.21	3/4" Female NPT With Viton® "O" Ring

Shut Off Valve features:

- One quarter turn polypropylene ball valve
- Used in liquid plumbing application as a quick shut off valve
- 75 P.S.I.

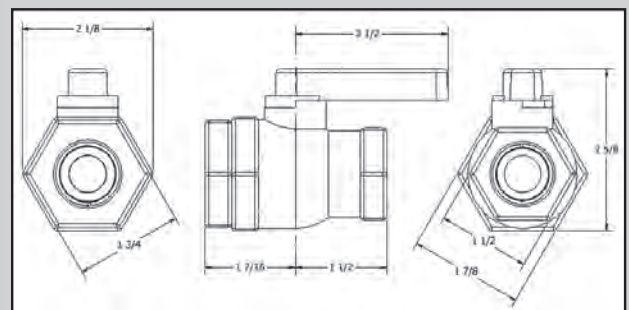



True Union Ball Valve

PART #	PRICE ea.	DESCRIPTION	HANDLE	Maximum PSI
TU050E	\$22.03	1/2" Female NPT, Full Port	T handle	125
TU050EL	\$23.89	1/2" Female NPT, Full Port	Lever handle	125
TU075E	\$24.35	3/4" Female NPT, Full Port	T handle	125
TU075EL	\$26.21	3/4" Female NPT, Full Port	Lever handle	125
TU100E	\$27.13	1" Female NPT, Standard Port	T handle	125
TU100EL	\$28.99	1" Female NPT, Standard Port	Lever handle	125
TU125E	\$36.40	1-1/4" Female NPT, Full Port	T handle	125
TU125EL	\$38.25	1-1/4" Female NPT, Full Port	Lever handle	125
TU150E	\$38.25	1-1/2" Female NPT, Full Port	T handle	125
TU150EL	\$40.11	1-1/2" Female NPT, Full Port	Lever handle	125
TU200E	\$45.67	2" Female NPT, Standard Port	T handle	125
TU200EL	\$47.76	2" Female NPT, Standard Port	Lever handle	125



Optional Lever Handle

PART #	PRICE ea.	DESCRIPTION
TU25	\$7.05	Lever handle for Small Valve (1/2" thru 1")
TU26	\$10.70	Lever handle for Large Valve (1 1/4" thru 2")

True Union Valve features:

- In-Line Repairable
- Sturdy construction, chemical coupled polypropylene
- Precision machined ball & multiple "O" ring seals prevent leaking
- 125 P.S.I. @ 140°F
- PTFE filled Polyethylene Seats
- E.P.D.M. seals standard (optional for Viton® & Buna seals)
- Optional Lever Handles



Optional T Handle

PART #	PRICE ea.	DESCRIPTION
TU15	\$5.69	T Handle for True Union Valve (for 1/2" thru 1")
TU16	\$10.25	T Handle for True Union Valve (for 1-1/4" thru 2")

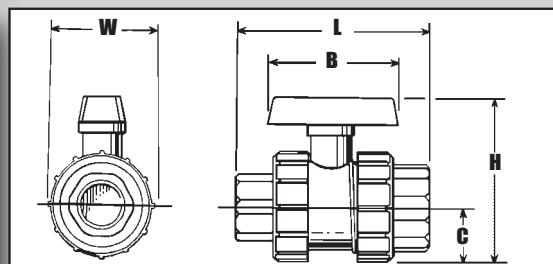

SIZE	B	L	H	C	W
1-1/4", 1-1/2", 2"	4-1/4"	6-1/4"	5-1/2"	1-7/8"	3-3/4"
1/2", 3/4", 1"	3-1/2"	4-3/4"	3-3/8"	1-1/8"	2-3/8"



Dry Poppet Couplings

PART #	PRICE ea.	DESCRIPTION	Size	Max. PSi
QD100F	\$90.02	Female Dry Poppet Coupler, 1" Female NPT Threads FKM (viton type) Seals	1"	70
QD100M	\$71.36	Male Dry Poppet Adapter, 1" Female NPT, 2" Buttress, Threads FKM (viton type) Seals	1"	70
NEW QD100NPS	\$71.36	Male Dry Poppet Adapter, 1" Female NPT, 2" NPS, Threads FKM (viton type) Seals	1"	70

Dry Poppet Coupling features:

- Lightweight
- Minimal Fluid Spillage
- Easy to Use
- Economical
- PTFE filled Polyethylene Seats
- Reduces Risk of Exposure
- Wide Range of Chemical Resistance
- Maximum Operating Pressure 70 P.S.I. @ 70°F
- Maximum Operating Temperature 150°F
- 30 GPM Maximum Flow
- Precision Molded in Polypropylene
- 1" Female NPT Threads

Applications:

- Agriculture
- Industrial
- Pharmaceutical
- Chemical processing

Cam Lever Couplings

FEATURED ITEMS —

3" x 2" Cam Couplers (pg 13)



After market research and study by the Green Leaf team an innovative solution was birthed to help enhance the product. The Gatorlock coupling was designed and patented to provide a market solution.

Safety

The GatorLock coupling was designed to provide enhanced safety with the exclusive cam lever locking mechanism. This mechanism helps reduce the possibility of unintentional opening of the cam levers during use, which could result in personal injury and costly spills.



Interchangeability

The CamLock series couplers are made to an industry standard and will interchange with all cam lever coupler brands & materials made to the universal specification.

Quality

Green Leaf is an ISO 9001 certified company. Gatorlock & CamLock couplers are manufactured at our Indiana facility to the highest quality standard in the industry.



B Series

PART #	PRICE ea.	DESCRIPTION
GLP050B	\$13.18	3/4" Female Coupler x 1/2" Male NPT
GLP075B	\$13.18	3/4" Female Coupler x 3/4" Male NPT
GLP100B	\$15.14	1" Female Coupler x 1" Male NPT
GLP125B	\$15.14	1" Female Coupler x 1-1/4" Male NPT
GLP150B	\$17.75	1-1/2" Female Coupler x 1-1/2" Male NPT
GLP200B	\$21.61	2" Female Coupler x 2" Male NPT
GLP300B	\$36.33	3" Female Coupler x 3" Male NPT



C Series

PART #	PRICE ea.	DESCRIPTION
GLP050C	\$13.18	3/4" Female Coupler x 1/2" Hose Barb
GLP075C	\$13.18	3/4" Female Coupler x 3/4" Hose Barb
GLP100C	\$15.14	1" Female Coupler x 1" Hose Barb
GLP125C	\$15.14	1" Female Coupler x 1-1/4" Hose Barb
GLP150C	\$17.75	1-1/2" Female Coupler x 1-1/2" Hose Barb
GLP200C	\$21.61	2" Female Coupler x 2" Hose Barb
GLP300C	\$36.33	3" Female Coupler x 3" Hose Barb



D Series

PART #	PRICE ea.	DESCRIPTION
GLP050D	\$13.18	3/4" Female Coupler x 1/2" Female NPT
GLP075D	\$13.18	3/4" Female Coupler x 3/4" Female NPT
GLP100D	\$15.14	1" Female Coupler x 1" Female NPT
GLP125D	\$15.14	1" Female Coupler x 1-1/4" Female NPT
GLP150D	\$17.75	1-1/2" Female Coupler x 1-1/2" Female NPT
GLP200D	\$21.61	2" Female Coupler x 2" Female NPT
GLP300D	\$36.33	3" Female Coupler x 3" Female NPT



CAP Series

PART #	PRICE ea.	DESCRIPTION
GLP050CAP	\$13.19	1/2" CAP for Male Adapter
GLP075CAP	\$13.19	3/4" CAP for Male Adapter
GLP100CAP	\$15.14	1" CAP for Male Adapter
GLP125CAP	\$15.14	1" CAP for Male Adapter
GLP150CAP	\$17.75	1-1/2" CAP for Male Adapter
GLP200CAP	\$21.61	2" CAP for Male Adapter
GLP300CAP	\$36.33	3" CAP for Male Adapter

Gatorlock Cam Coupling features:

- Patented Locking Arms to reduce possibility of unintentional opening of cam levers during use.
- Glass Filled Polypropylene
- 1/2" thru 2" Maximum Operating Pressure 125 psi @ 70°F.
- 3" Maximum Operating Pressure 75 psi @ 70°F.
- E.P.D.M. Gaskets

1/2"series couplings interchange with 3/4" size couplings. Coupling ends are 3/4" size.
 1-1/4"series couplings interchange with 1" size couplings. Coupling ends are 1" size.





1/2"

PART #	PRICE ea.	DESCRIPTION
050A	\$5.24	3/4" Male Adapter x 1/2" Female NPT
050B	\$11.99	3/4" Female Coupler x 1/2" Male NPT
050C	\$11.99	3/4" Female Coupler x 1/2" Hose Barb
050D	\$11.99	3/4" Female Coupler x 1/2" Female NPT
050E	\$5.67	3/4" Male Adapter x 1/2" Hose Barb
050F	\$5.67	3/4" Male Adapter x 1/2" Male NPT
050CAP	\$11.99	1/2" CAP for Male Adapter
050PL	\$5.67	1/2" Plug for Female Coupler

3/4"

PART #	PRICE ea.	DESCRIPTION
075A	\$5.24	3/4" Male Adapter x 3/4" Female NPT
075B	\$11.99	3/4" Female Coupler x 3/4" Male NPT
075C	\$11.99	3/4" Female Coupler x 3/4" Hose Barb
075D	\$11.99	3/4" Female Coupler x 3/4" Female NPT
075E	\$5.67	3/4" Male Adapter x 3/4" Hose Barb
075F	\$5.67	3/4" Male Adapter x 3/4" Male NPT
075CAP	\$11.99	3/4" CAP for Male Adapter
075PL	\$5.67	3/4" Plug for Female Coupler

1"

PART #	PRICE ea.	DESCRIPTION
100A	\$5.24	1" Male Adapter x 1" Female NPT
100B	\$13.78	1" Female Coupler x 1" Male NPT
100C	\$13.78	1" Female Coupler x 1" Hose Barb
100D	\$13.78	1" Female Coupler x 1" Female NPT
100E	\$6.29	1" Male Adapter x 1" Hose Barb
100F	\$6.29	1" Male Adapter x 1" Male NPT
100CAP	\$13.23	1" CAP for Male Adapter
100PL	\$5.46	1" Plug for Female Coupler

1" x 1-1/4"

PART #	PRICE ea.	DESCRIPTION
125A	\$5.24	1" Male Adapter x 1-1/4" Female NPT
125B	\$13.78	1" Female Coupler x 1-1/4" Male NPT
125C	\$13.78	1" Female Coupler x 1-1/4" Hose Barb
125D	\$13.78	1" Female Coupler x 1-1/4" Female NPT
125E	\$6.29	1" Male Adapter x 1-1/4" Hose Barb
125F	\$6.29	1" Male Adapter x 1-1/4" Male NPT
125CAP	\$13.23	1" CAP for Male Adapter
125PL	\$5.46	1" Plug for Female Coupler

Cam Lever Coupling features:

- Glass Filled Polypropylene
- 1/2" thru 2" Maximum Operating Pressure 125 psi @ 70°F.
- 3" and 4" Maximum Operating Pressure 75 psi @ 70°F.
- E.P.D.M. Gaskets

1/2"series couplings interchange with 3/4" size couplings. Coupling ends are 3/4" size.

1-1/4"series couplings interchange with 1" size couplings. Coupling ends are 1" size.

*Product may vary depending on size.



1-1/2" x 1-1/4"

PART #	PRICE ea.	DESCRIPTION
150125A	\$5.95	1-1/2" Male Adapter x 1-1/4" Female NPT
150125B	\$16.15	1-1/2" Female Coupler x 1-1/4" Male NPT
150125C	\$16.15	1-1/2" Female Coupler x 1-1/4" Hose Barb
150125D	\$16.15	1-1/2" Female Coupler x 1-1/4" Female NPT
150125E	\$6.30	1-1/2" Male Adapter x 1-1/4" Hose Barb
150125F	\$6.30	1-1/2" Male Adapter x 1-1/4" Male NPT

1-1/2"

PART #	PRICE ea.	DESCRIPTION
150A	\$5.95	1-1/2" Male Adapter x 1-1/2" Female NPT
150B	\$16.15	1-1/2" Female Coupler x 1-1/2" Male NPT
150C	\$16.15	1-1/2" Female Coupler x 1-1/2" Hose Barb
150D	\$16.15	1-1/2" Female Coupler x 1-1/2" Female NPT
150E	\$6.30	1-1/2" Male Adapter x 1-1/2" Hose Barb
150F	\$6.30	1-1/2" Male Adapter x 1-1/2" Male NPT
150CAP	\$16.15	1-1/2" CAP for Male Adapter
150PL	\$6.10	1-1/2" Plug for Female Coupler

2"

PART #	PRICE ea.	DESCRIPTION
200A	\$7.02	2" Male Adapter x 2" Female NPT
200B	\$19.67	2" Female Coupler x 2" Male NPT
200C	\$19.67	2" Female Coupler x 2" Hose Barb
200D	\$19.67	2" Female Coupler x 2" Female NPT
200E	\$8.29	2" Male Adapter x 2" Hose Barb
200F	\$8.29	2" Male Adapter x 2" Male NPT
200CAP	\$19.67	2" CAP for Male Adapter
200PL	\$8.23	2" Plug for Female Coupler

3"

PART #	PRICE ea.	DESCRIPTION
300A	\$16.96	3" Male Adapter x 3" Female NPT
300B	\$33.06	3" Female Coupler x 3" Male NPT
300C	\$33.06	3" Female Coupler x 3" Hose Barb
300D	\$33.06	3" Female Coupler x 3" Female NPT
300E	\$21.74	3" Male Adapter x 3" Hose Barb
300F	\$21.74	3" Male Adapter x 3" Male NPT
300CAP	\$33.06	3" CAP for Male Adapter
300PL	\$17.24	3" Plug for Female Coupler

4" (3 Arms)

PART #	PRICE ea.	DESCRIPTION
400A	\$25.87	4" Male Adapter x 4" Female NPT
400B	\$65.52	4" Female Coupler x 4" Male NPT
400C	\$65.52	4" Female Coupler x 4" Hose Barb
400D	\$65.52	4" Female Coupler x 4" Female NPT
400E	\$25.87	4" Male Adapter x 4" Hose Barb
400F	\$25.87	4" Male Adapter x 4" Male NPT
400CAP	\$47.78	4" CAP for Male Adapter
400PL	\$20.34	4" Plug for Female Coupler

Cam Lever Coupling features:

- Glass Filled Polypropylene
- 1/2" thru 2" Maximum Operating Pressure 125 psi @ 70°F.
- 3" and 4" Maximum Operating Pressure 75 psi @ 70°F.
- E.P.D.M. Gaskets

1/2"series couplings interchange with 3/4" size couplings. Coupling ends are 3/4" size.

1-1/4"series couplings interchange with 1" size couplings. Coupling ends are 1" size.

*Product may vary depending on size.

NEW



2" x 3" Series

PART #	PRICE ea.	DESCRIPTION
300200F	\$9.39	2" Male Adapter x 3" Male NPT
300200A	\$9.39	2" Male Adapter x 3" Female NPT
NEW 300B200A	\$33.06	3" Female Coupler x 2" Male Adapter
NEW 300200D	\$33.06	3" Female Coupler x 2" Female NPT
NEW GLP300B200A	\$36.33	3" Female Coupler x 2" Male Adapter
NEW GLP300200D	\$36.33	3" Female Coupler x 2" Female NPT



Garden Hose Couplings

Polypropylene Garden Hose Couplings used to connect a Female GHT to a Male GHT

PART #	PRICE ea.	SIZE & DESCRIPTION
GLP075AG	\$5.79	3/4" Female GHT x 3/4" Male Adapter
GLP075BG	\$12.07	3/4" Male GHT x 3/4" Female Adapter
GLP075DG	\$12.07	3/4" Female GHT x 3/4" Female Coupler
GLP075FG	\$5.79	3/4" Male GHT x 3/4" Male Adapter

Use either of the valve connectors as a quick shutoff at the end of any garden hose.



AL 90° Series

PART #	PRICE ea.	DESCRIPTION
150A90	\$10.32	1-1/2" Male Adapter x 1-1/2" Female NPT
200A90	\$11.78	2" Male Adapter x 2" Female NPT



CL 90° Series

PART #	PRICE ea.	DESCRIPTION
150C90	\$23.22	1-1/2" Female Coupler x 1-1/2" Hose Shank
200C90	\$26.37	2" Female Coupler x 2" Hose Shank



DL 90° Series

PART #	PRICE ea.	DESCRIPTION
150D90	\$23.22	1-1/2" Female Coupler x 1-1/2" Female NPT
200D90	\$26.37	2" Female Coupler x 2" Female NPT



FL 90° Series

PART #	PRICE ea.	DESCRIPTION
150F90	\$12.37	1-1/2" Male Adapter x 1-1/2" Male NPT
200F90	\$13.27	2" Male Adapter x 2" Male NPT



45° F Series

PART #	PRICE ea.	DESCRIPTION
200F45	\$18.91	2" Male Adapter x 2" Male NPT

90 Degree Coupling features:

- Glass Filled Polypropylene
- Maximum Operating Pressure 125 P.S.I. @ 70°F
- E.P.D.M. Gaskets

NEW



Shims

PART #	PRICE ea.	DESCRIPTION
SHIM075	\$0.84	3/4" Gasket Shim
SHIM100	\$0.93	1" Gasket Shim
SHIM150	\$1.34	1-1/2" Gasket Shim
SHIM200	\$1.70	2" Gasket Shim
SHIM300	\$3.19	3" Gasket Shim
SHIM400	\$4.53	4" Gasket Shim

NEW



Replacement Gasket

PART #	PRICE ea.	DESCRIPTION
75G	\$0.95	1/2" & 3/4" EPDM Gasket
100G	\$0.95	1" & 1-1/4" EPDM Gasket
150G	\$0.95	1-1/2" EPDM Gasket
200G	\$1.06	2" EPDM Gasket
300G	\$1.45	3" EPDM Gasket
400G	\$3.41	4" EPDM Gasket
75GXT	\$1.42	3/4" Xtra Thick Gasket
100GXT	\$1.55	1" Xtra Thick Gasket
150GXT	\$1.80	1-1/2" Xtra Thick Gasket
200GXT	\$2.25	2" Xtra Thick Gasket
300GXT	\$2.99	3" Xtra Thick Gasket



Bulkhead Fitting

External Thread and nut are left hand threads.
Internal Thread is FPT.
For use with tanks having a wall thickness of 1/16" to 1/2".

Material:

- Body and Nut are Nylon (N)
- Friction washer is Polyethylene
- Sealing washer is either Buna (B), EPDM (E) or Santoprene.

Nylon, Buna and Polyethylene used in manufacturing are FDA approved grade.

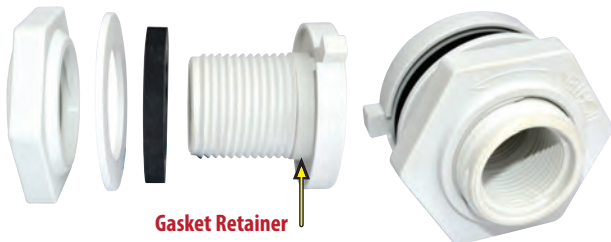

Gasket Retainer

PART #		THREAD	WASHER	HOLE SIZE
INTERNAL SEALING				
NYLON	PRICE ea.			
TF12NB	\$6.66	1/2" Female NPT	BUNA	1-1/4"
TF12NE	\$6.32	1/2" Female NPT	EPDM	1-1/4"
TF34NB	\$6.66	3/4" Female NPT	BUNA	1-3/8"
TF34NE	\$6.32	3/4" Female NPT	EPDM	1-3/8"

Bulkhead Fitting

External Thread and nut are left hand threads.
Internal Thread is FPT.
For use with tanks having a wall thickness of 1/16" to 1/2".

Material:

- Body and Nut are Polypropylene (P)
- Friction washer is Polyethylene
- Sealing washer is either Buna (B), EPDM (E) or Santoprene.

Nylon, Buna and Polyethylene used in manufacturing are FDA approved grade.

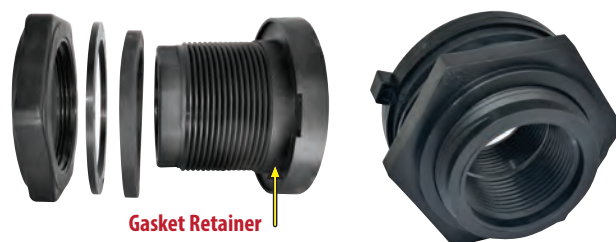

Gasket Retainer

PART #		THREAD	WASHER	HOLE SIZE
INTERNAL SEALING				
POLY	PRICE ea.			
TF12PB	\$6.66	1/2" Female NPT	BUNA	1-1/4"
TF12PE	\$6.32	1/2" Female NPT	EPDM	1-1/4"
TF34PB	\$6.66	3/4" Female NPT	BUNA	1-3/8"
TF34PE	\$6.32	3/4" Female NPT	EPDM	1-3/8"
TF100PE	\$8.03	1" Female NPT	EPDM	1-3/4"
TF125PE	\$9.79	1 1/4" Female NPT	EPDM	2-1/4"
TF150PE	\$14.01	1 1/2" Female NPT	EPDM	3"
TF200PE	\$14.01	2" Female NPT	EPDM	3"
TF300PE	\$43.78	3" Female NPT	EPDM	4-1/2"
TF400PE	\$113.82	4" Female NPT	EPDM	5-3/4"

Outlet Flange (OF)

For use when access to inside of tank is available
Fits Tank Wall thickness from 1/4" - 1/2"

- Polypropylene Flanges
- Stainless Steel bolts, nuts & washers
- EPDM Gaskets

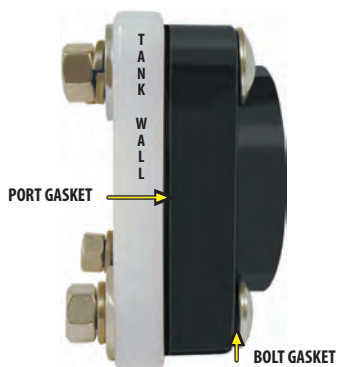

PART #	PRICE ea.	DESCRIPTION
OF125	\$30.32	1-1/4" Female NPT Full Port
OF150	\$30.32	1-1/2" Female NPT Full Port
OF200FP	\$34.80	2" Female NPT Full Port

Inside Bolt Seal Double Seal Flange (DS)

Nuts are tightened from outside of tank
Fits Tank Wall thickness from 1/4" - 1/2"

- Polypropylene Flanges
- Stainless Steel bolts, nuts & washers
- EPDM Gaskets

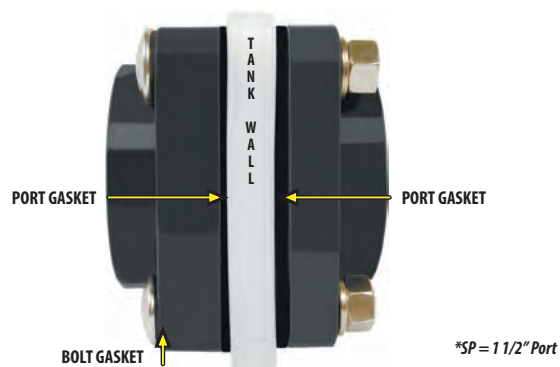

*SP = 1 1/2" Port

PART #	PRICE ea.	INLET	x	OUTLET
DS125	\$42.37	2" SP*		1-1/4" Full Port
DS150	\$42.37	2" SP*		1-1/2" Full Port
DS200FP	\$46.60	2" Full Port		2" Full Port

Black Poly Top & Bowl In-Line Strainer

PART #	PRICE ea.	DESCRIPTION
LST05050	\$28.14	1/2" Poly T-Strainer 50 Mesh
LST05080	\$28.14	1/2" Poly T-Strainer 80 Mesh
LST07550	\$28.14	3/4" Poly T-Strainer 50 Mesh
LST07580	\$28.14	3/4" Poly T-Strainer 80 Mesh
LST10050	\$44.14	1" Poly T-Strainer 50 Mesh
LST10080	\$44.14	1" Poly T-Strainer 80 Mesh
LST12550	\$47.44	1-1/4" Poly T-Strainer 50 Mesh
LST12580	\$47.44	1-1/4" Poly T-Strainer 80 Mesh
LST15050	\$54.46	1-1/2" Poly T-Strainer 50 Mesh
LST15080	\$54.46	1-1/2" Poly T-Strainer 80 Mesh



- EPDM Gaskets
- Stainless Steel Screens

Replacement Gaskets & Screens Available

Black Poly Top & Clear Nylon Bowl In-Line Strainer

PART #	PRICE ea.	DESCRIPTION
LSTM05050C	\$30.84	1/2" Poly T-Strainer 50 Mesh
LSTM05080C	\$30.84	1/2" Poly T-Strainer 80 Mesh
LSTM07550C	\$30.84	3/4" Poly T-Strainer 50 Mesh
LSTM07580C	\$30.84	3/4" Poly T-Strainer 80 Mesh
LSTM10050C	\$56.49	1" Poly T-Strainer 50 Mesh
LSTM10080C	\$56.49	1" Poly T-Strainer 80 Mesh
LSTM12550C	\$59.79	1-1/4" Poly T-Strainer 50 Mesh
LSTM12580C	\$59.79	1-1/4" Poly T-Strainer 80 Mesh
LSTM15050C	\$66.81	1-1/2" Poly T-Strainer 50 Mesh
LSTM15080C	\$66.81	1-1/2" Poly T-Strainer 80 Mesh



- EPDM Gaskets
- Stainless Steel Screens

Replacement Gaskets & Screens Available

White Nylon Top & Clear Nylon Bowl In-Line Strainer

PART #	PRICE ea.	DESCRIPTION
LSTM05050NC	\$33.97	1/2" Poly T-Strainer 50 Mesh
LSTM05080NC	\$33.97	1/2" Poly T-Strainer 80 Mesh
LSTM07550NC	\$33.97	3/4" Poly T-Strainer 50 Mesh
LSTM07580NC	\$33.97	3/4" Poly T-Strainer 80 Mesh
LSTM10050NC	\$69.71	1" Poly T-Strainer 50 Mesh
LSTM10080NC	\$69.71	1" Poly T-Strainer 80 Mesh
LSTM12550NC	\$73.09	1-1/4" Poly T-Strainer 50 Mesh
LSTM12580NC	\$73.09	1-1/4" Poly T-Strainer 80 Mesh
LSTM15050NC	\$74.84	1-1/2" Poly T-Strainer 50 Mesh
LSTM15080NC	\$79.44	1-1/2" Poly T-Strainer 80 Mesh



- EPDM Gaskets
- Stainless Steel Screens

Replacement Gaskets & Screens Available

Polypropylene Basket Suction Strainer

Polypropylene Strainer



PART #	PRICE ea.	DESCRIPTION
SR150P	\$15.55	1-1/2" Female NPT
SR200P	\$15.55	2" Female NPT
SR300P	\$26.55	3" Female NPT

Round Hole Steel Basket Strainer

Zinc Plated, with standard Pipe Threads



PART #	PRICE ea.	DESCRIPTION
SR125SP	\$23.78	1-1/4" Female NPT
SR150SP	\$23.78	1-1/2" Female NPT
SR200SP	\$28.78	2" Female NPT
SR300SP	\$48.50	3" Female NPT



Schedule 80

Selection

Schedule 80 heavy duty fittings are available in sizes ranging from 1/2" to 3".

Durability

Green Leaf's hose & pipe fittings are utilized for a variety of agricultural, plumbing and industrial liquid-handling solutions.

Polypropylene

Our resin is a high strength custom blended glass filled polypropylene.

Custom

Can't find what you're looking for in our fitting line? No worries, we make custom fittings as well!

Knowledge

Let us use our expertise to help you make the right choice.

Experience

We have been producing high quality fittings over 4 decades.



NEW SIZES AVAILABLE



Straight Adapter

	PART #	PRICE ea.	SIZE & DESCRIPTION
NEW	HB025	\$1.35	1/4" Male NPT x 1/4" Hose Barb
NEW	HB025038	\$1.35	1/4" Male NPT x 3/8" Hose Barb
NEW	HB025050	\$1.63	1/4" Male NPT x 1/2" Hose Barb
NEW	HB038	\$1.46	3/8" Male NPT x 3/8" Hose Barb
NEW	HB038025	\$1.22	3/8" Male NPT x 1/4" Hose Barb
NEW	HB038050	\$1.46	3/8" Male NPT x 1/2" Hose Barb
NEW	HB050038	\$1.46	1/2" Male NPT x 3/8" Hose Barb
NEW	HB050	\$1.36	1/2" Male NPT x 1/2" Hose Barb
NEW	HB050075	\$1.62	1/2" Male NPT x 3/4" Hose Barb
	HB075038	\$1.63	3/4" Male NPT x 3/8" Hose Barb
	HB075050	\$1.50	3/4" Male NPT x 1/2" Hose Barb
	HB075	\$1.50	3/4" Male NPT x 3/4" Hose Barb
NEW	HB075100	\$1.84	3/4" Male NPT x 1" Hose Barb
	HB100075	\$1.84	1" Male NPT x 3/4" Hose Barb
	HB100	\$1.84	1" Male NPT x 1" Hose Barb
NEW	HB100125	\$2.27	1" Male NPT x 1-1/4" Hose Barb
NEW	HB125100	\$2.27	1-1/4" Male NPT x 1" Hose Barb
	HB125	\$2.27	1-1/4" Male NPT x 1-1/4" Hose Barb
	HB150100	\$3.68	1-1/2" Male NPT x 1" Hose Barb
	HB150125	\$3.09	1-1/2" Male NPT x 1-1/4" Hose Barb
NEW	HB150	\$3.46	1-1/2" Male NPT x 1-1/2" Hose Barb
NEW	HB150200	\$5.31	1-1/2" Male NPT x 2" Hose Barb
NEW	HB200150	\$5.31	2" Male NPT x 1-1/2" Hose Barb
	HB200	\$4.23	2" Male NPT x 2" Hose Barb
NEW	HB300	\$13.66	3" Male NPT x 3" Hose Barb

NEW SIZES AVAILABLE



90° Hose Barb

	PART #	PRICE ea.	DESCRIPTION
NEW	HB07590	\$1.73	3/4" Male NPT x 3/4" Hose Barb 90° Elbow
NEW	HB10090	\$2.22	1" Male NPT x 1" Hose Barb 90° Elbow
NEW	HB12590	\$2.72	1-1/4" Male NPT x 1-1/4" Hose Barb 90° Elbow
	HB15090	\$7.83	1-1/2" Male NPT x 1-1/2" Hose Barb 90° Elbow
	HB20090	\$8.57	2" Male NPT x 2" Hose Barb 90° Elbow
	HB30090	\$41.45	3" Male NPT x 3" Hose Barb 90° Elbow



Nipple

	PART #	PRICE ea.	DESCRIPTION
	M1800P	\$0.64	1/8" Male NPT Short Poly Nipple
	M1400P	\$0.72	1/4" Male NPT Short Poly Nipple
	M3800P	\$0.75	3/8" Male NPT Short Poly Nipple
	M1200P	\$0.77	1/2" Male NPT Short Poly Nipple
	M3400P	\$0.88	3/4" Male NPT Short Poly Nipple
NEW	M0754P	\$3.20	3/4" Male NPT x 4" Poly Nipple
	M1000P	\$1.29	1" Male NPT Short Poly Nipple
NEW	M1004P	\$3.39	1" Male NPT x 4" Poly Nipple
NEW	M1006P	\$4.22	1" Male NPT x 6" Poly Nipple
	M1140P	\$2.20	1-1/4" Male NPT Short Poly Nipple
NEW	M1254P	\$4.22	1-1/4" Male NPT x 4" Poly Nipple
NEW	M1256P	\$4.91	1-1/4" Male NPT x 6" Poly Nipple
	M1120P	\$2.88	1-1/2" Male NPT Short Poly Nipple
	M1124P	\$7.59	1-1/2" Male NPT x 4" Poly Nipple
	M1126P	\$8.93	1-1/2" Male NPT x 6" Poly Nipple
	M2000P	\$4.19	2" Male NPT Short Poly Nipple
	M2004P	\$8.84	2" Male NPT x 4" Poly Nipple
	M2006P	\$10.31	2" Male NPT x 6" Poly Nipple
	M3000P	\$13.13	3" Male NPT Short Poly Nipple
	M3006P	\$25.45	3" Male NPT x 6" Poly Nipple

NEW SIZES AVAILABLE



Straight Hose Mender

	PART #	PRICE ea.	DESCRIPTION
NEW	HM075	\$1.42	3/4" Hose Barb x 3/4" Hose Barb
NEW	HM100	\$1.73	1" Hose Barb x 1" Hose Barb
NEW	HM125	\$1.95	1-1/4" Hose Barb x 1-1/4" Hose Barb
NEW	HM150	\$3.46	1-1/2" Hose Barb x 1-1/2" Hose Barb
	HM200	\$4.35	2" Hose Barb x 2" Hose Barb
	HM300	\$13.55	3" Hose Barb x 3" Hose Barb

NEW SIZES AVAILABLE



Reducing Nipple

	PART #	PRICE ea.	DESCRIPTION
NEW	RN075050	\$2.63	3/4" Male NPT x 1/2" Male NPT
NEW	RN100075	\$2.84	1" Male NPT x 3/4" Male NPT
NEW	RN150100	\$3.82	1-1/2" Male NPT x 1" Male NPT
	RN200150	\$3.16	2" Male NPT x 1-1/2" Male NPT
	RN300200	\$13.08	3" Male NPT x 2" Male NPT



NEW SIZES AVAILABLE



Reducing Coupling

PART #	PRICE ea.	DESCRIPTION
RC100075	\$7.33	1" Female NPT x 3/4" Female NPT
RC150100	\$12.44	1-1/2" Female NPT x 1" Female NPT
RC200100	\$10.85	2" Female NPT x 1" Female NPT
RC200150	\$11.02	2" Female NPT x 1-1/2" Female NPT
RC300200	\$39.12	3" Female NPT x 2" Female NPT



Coupling

PART #	PRICE ea.	DESCRIPTION
CPLG075	\$4.12	3/4" Female NPT x 3/4" Female NPT
CPLG100	\$4.70	1" Female NPT x 1" Female NPT
CPLG150	\$10.52	1-1/2" Female NPT x 1-1/2" Female NPT
CPLG200	\$11.99	2" Female NPT x 2" Female NPT
CPLG300	\$33.94	3" Female NPT x 3" Female NPT



Street Elbow

PART #	PRICE ea.	DESCRIPTION
SE14P	\$3.14	1/4" Female NPT x 1/4" Male NPT 90° Street Elbow
SE38P	\$3.19	3/8" Female NPT x 3/8" Male NPT 90° Street Elbow
SE12P	\$3.24	1/2" Female NPT x 1/2" Male NPT 90° Street Elbow
SE1234P	\$3.35	3/4" Female NPT x 1/2" Male NPT 90° Street Elbow
SE34P	\$3.71	3/4" Female NPT x 3/4" Male NPT 90° Street Elbow
SE100P	\$4.78	1" Female NPT x 1" Male NPT 90° Street Elbow
SE114P	\$6.57	1-1/4" Female NPT x 1-1/4" Male NPT 90° Street Elbow
SE112P	\$8.03	1-1/2" Female NPT x 1-1/2" Male NPT 90° Street Elbow
SE200P	\$8.55	2" Female NPT x 2" Male NPT 90° Street Elbow
SE300P	\$56.24	3" Female NPT x 3" Male NPT 90° Street Elbow



45° Street Elbow

PART #	PRICE ea.	DESCRIPTION
SL15045	\$12.60	1-1/2" Female NPT x 1-1/2" Male NPT 45° Street Elbow
SL20045	\$14.91	2" Female NPT x 2" Male NPT 45° Street Elbow



Elbow

PART #	PRICE ea.	DESCRIPTION
ELF12P	\$3.04	1/2" Female NPT x 1/2" Female NPT
ELF34P	\$3.40	3/4" Female NPT x 3/4" Female NPT
ELF100P	\$4.60	1" Female NPT x 1" Female NPT
ELF114P	\$6.32	1-1/4" Female NPT x 1-1/4" Female NPT
ELF112P	\$7.98	1-1/2" Female NPT x 1-1/2" Female NPT
ELF200P	\$10.72	2" Female NPT x 2" Female NPT
ELF300P	\$55.11	3" Female NPT x 3" Female NPT

NEW SIZES AVAILABLE



Reducer Bushing

PART #	PRICE ea.	SIZE & DESCRIPTION
NEW RB050038	\$2.70	1/2" Male NPT x 3/8" Female NPT
NEW RB075050	\$2.70	3/4" Male NPT x 1/2" Female NPT
NEW RB100075	\$2.86	1" Male NPT x 3/4" Female NPT
NEW RB125100	\$2.86	1-1/4" Male NPT x 1" Female NPT
NEW RB150125	\$3.79	1-1/2" Male NPT x 1-1/4" Female NPT
NEW RB200150	\$4.20	2" Male NPT x 1-1/2" Female NPT
NEW RB300200HD	\$17.17	3" Male NPT x 2" Female NPT



Tee

PART #	PRICE ea.	DESCRIPTION
TT14P	\$3.85	1/4" Female NPT
TT12P	\$3.97	1/2" Female NPT
TT34P	\$4.93	3/4" Female NPT
TT100P	\$6.48	1" Female NPT
TT114P	\$8.21	1-1/4" Female NPT
TT112P	\$10.09	1-1/2" Female NPT
TT200P	\$13.36	2" Female NPT
TT300P	\$56.14	3" Female NPT



Tee w Gauge Port

PART #	PRICE ea.	DESCRIPTION
TT1214P	\$6.70	1/2" Female NPT x 1/4" Gauge Port
TT3414P	\$8.76	3/4" Female NPT x 1/4" Gauge Port
TT10014P	\$10.82	1" Female NPT x 1/4" Gauge Port



Pipe Caps

PART #	PRICE ea.	DESCRIPTION
CAP050	\$5.53	1/2" Female NPT Poly Cap
CAP075	\$5.53	3/4" Female NPT Poly Cap
CAP100	\$5.53	1" Female NPT Poly Cap
CAP125	\$6.22	1-1/4" Female NPT Poly Cap
CAP150	\$7.83	1-1/2" Female NPT Poly Cap
CAP200	\$9.08	2" Female NPT Poly Cap
CAP300	\$32.53	3" Female NPT Poly Cap

NEW SIZES AVAILABLE



Plug

	PART #	PRICE ea.	DESCRIPTION
NEW	PLUG050	\$3.43	1/2" Plug
NEW	PLUG075	\$3.43	3/4" Plug
NEW	PLUG100	\$3.43	1" Plug
NEW	PLUG150	\$4.56	1-1/2" Plug
NEW	PLUG200	\$4.56	2" Plug
NEW	PLUG300	\$17.98	3" Plug



Steel Plated Straight Adapters

PART #	PRICE ea.	SIZE & DESCRIPTION
CN050SP	\$3.84	1/2" Male NPT x Hose Barb
CN075SP	\$4.00	3/4" Male NPT x Hose Barb
CN100SP	\$5.14	1" Male NPT x Hose Barb
CN125SP	\$6.91	1-1/4" Male NPT x Hose Barb
CN150SP	\$8.86	1-1/2" Male NPT x Hose Barb
CN200SP	\$12.06	2" Male NPT x Hose Barb



Pin Lug Couplers

- Pin Lug Hose Barb Couplers (Full Sets)
- Aluminum Shank with Brass Swivel Nut

PART #	PRICE ea.	DESCRIPTION
PL150DP	\$21.86	1-1/2" Hose Barbs
PL200DP	\$28.99	2" Hose Barbs
PG150NBR	\$1.60	1-1/2" Gasket
PG200NBR	\$1.60	2" Gasket

NEW



Pressure Seal HD Clamps

- 5/8" Band Width
- 300 Stainless Steel construction
- 150 in/lbs ultimate torque
- Spring compression of liner creates 360° pressure on hose
- Trough feature exerts additional pressure on hose

PRESSURE SEAL HD CLAMPS		
PART #	PRICE ea.	DIAMETER RANGE (inches)
K38215-0238	\$11.52	1.62 - 2.12
K38215-0262	\$11.65	1.88 - 2.37
K38215-0275	\$11.98	2.00 - 2.50
K38215-0288	\$12.12	2.12 - 2.62
K38215-0300	\$12.25	2.25 - 2.75
K38215-0325	\$12.25	2.50 - 3.00
K38215-0350	\$12.39	2.75 - 3.25
K38215-0375	\$12.59	2.88 - 3.50
K38215-0400	\$12.99	3.12 - 3.75
K38215-0425	\$13.19	3.31 - 4.00
K38215-0450	\$14.19	3.44 - 4.25
K38215-0512	\$14.53	4.06 - 4.87

NEW



T Bolt Clamps

- Heavy Duty - 30011 Series T-Bolt
- T-Bolt - 1/4" 300 Stainless Steel
- Hex Nut - 7/16" 300 Stainless Steel w/Nylon Insert
- Band - 3/4" or 7/8" 300 Stainless Steel
- Bridge - 3/4" 300 Stainless Steel
- Trunnion - 300 Stainless Steel
- Installation Torque - 75-90 in/lbs (4Nm)

T BOLT CLAMPS		
PART #	PRICE ea.	DIAMETER RANGE (inches) /Size
TC120	\$9.76	1.20 - 1.34 / Size 120
TC130	\$10.75	1.30 - 1.50 / Size 130
TC150	\$10.85	1.50 - 1.76 / Size 150
TC162	\$9.85	1.62 - 1.87 / Size 162
TC181	\$9.85	1.81 - 2.06 / Size 181
TC193	\$10.13	1.93 - 2.18 / Size 218
TC206	\$11.36	2.06 - 2.40 / Size 206
TC218	\$10.13	2.18 - 2.50 / Size 218
TC224	\$11.36	2.24 - 2.55 / Size 224
TC231	\$10.33	2.31 - 2.69 / Size 231
TC250	\$11.36	2.50 - 2.81 / Size 250
TC287	\$11.36	2.87 - 3.18 / Size 287
TC312	\$11.62	3.12 - 3.49 / Size 312
TC331	\$11.03	3.31 - 3.62 / Size 331
TC343	\$11.03	3.43 - 3.81 / Size 343
TC350	\$11.03	3.50 - 3.81 / Size 425
TC425	\$13.14	4.25 - 4.56 / Size 425
TC438	\$21.91	4.38 - 4.76 / Size 438
TC456	\$21.91	4.56 - 4.94 / Size 456

NEW



Flange Clamps

- 300 Series Stainless Steel
- Band thickness .028
- Band Width 9/16"
- Shipped at maximum diameter

FLANGE CLAMPS		
PART #	PRICE ea.	DESCRIPTION
FC100	\$10.81	300 SS, Flange Clamp 1"
FC200	\$12.45	300 SS, Flange Clamp 2"
FC220	\$13.66	300 SS, Flange Clamp 2" Full Port
FC300	\$18.83	303 SS, Flange Clamp 3"

NEW



Bolted Flange Clamps

- 300 Series Stainless Steel
- 150 in/lbs torque

BOLTED FLANGE CLAMPS		
PART #	PRICE ea.	DESCRIPTION
FC220B	\$49.96	220 HD Flange Clamp Bolted
FC300B	\$55.62	300 HD Flange Clamp Bolted

NEW



Hose Clamps

- Worm Gear - 67 Series 1/2" Hy Gear Band
- Screw - 5/16" Hex Head; 410 Stainless Steel
- Housing - 200 Stainless Steel
- Band - 1/2"; 200 Stainless Steel
- Installation Torque - 35 in/lbs (4Nm)

HOSE CLAMPS		
PART #	PRICE ea.	DIAMETER RANGE (inches) / Size
K62604	\$1.34	.250 - .625 / Size 4 micro
K62606	\$1.34	.312 - .875 / Size 6 micro
K6706-1	\$2.08	.375 - .875 / Size 6
K6708-1	\$2.08	.437 - 1.00 / Size 8
K6710-1	\$2.21	.500 - 1.06 / Size 10
K6712-1	\$2.21	.500 - 1.25 / Size 12
K6716-1	\$2.21	.687 - 1.50 / Size 16
K6720-1	\$2.21	.750 - 1.75 / Size 20
K6724-1	\$2.21	1.00 - 2.00 / Size 24
K6728-1	\$2.34	1.25 - 2.25 / Size 28
K6732-1	\$2.34	1.50 - 2.50 / Size 32
K6736-1	\$2.34	.750 - 2.75 / Size 36
K6740-1	\$2.34	1.00 - 3.00 / Size 40
K6744-1	\$2.35	1.25 - 3.25 / Size 44
K6748-1	\$2.48	1.50 - 3.50 / Size 48
K6756-1	\$2.81	2.00 - 4.00 / Size 56
K6764-1	\$3.15	2.50 - 4.50 / Size 64
K6780-1	\$4.69	3.50 - 5.50 / Size 80
K6796-1	\$4.95	4.50 - 6.50 / Size 96
K67104	\$5.16	5.00 - 7.00 / Size 104



Fittings

Selection

Hose, pipe, garden hose, nozzle and heavy duty fittings are available in sizes ranging from 1/8" to 3".

Durability

Green Leaf's hose & pipe fittings are utilized for a variety of agricultural, plumbing and industrial liquid-handling solutions.

Polypropylene

Our resin is a high strength custom blended glass filled polypropylene.

Nylon

Green Leaf's hose & pipe fittings are certified by NSF International NSF/ANSI Standard 61 – Drinking Water System Components, Health Effects and NSF/ANSI Standard 372 – Drinking Water System Components, Lead Content.

Experience

We have been manufacturing top quality fittings since 1983.

Straight Adapter

Use in conjunction with a hose clamp and quality thread sealant.



PART #				THREAD	HOSE BARB
NYLON	PRICE ea.	POLY	PRICE ea.	Male NPT x HOSE BARB	
A18316	\$0.63			1/8"	3/16"
A1814	\$0.47	A1814P	\$0.68	1/8"	1/4"
A18516	\$0.65			1/8"	5/16"
A1838	\$0.47	A1838P	\$0.68	1/8"	3/8"
A1812	\$0.53	A1812P	\$0.68	1/8"	1/2"
A1414	\$0.47	A1414P	\$0.66	1/4"	1/4"
A14516	\$0.77			1/4"	5/16"
A1438	\$0.48	A1438P	\$0.67	1/4"	3/8"
A1412	\$0.50	A1412P	\$0.68	1/4"	1/2"
A1458	\$0.91	A1458P	\$1.27	1/4"	5/8"
A1434	\$0.93	A1434P	\$1.30	1/4"	3/4"
A3814	\$0.49	A3814P	\$0.68	3/8"	1/4"
A38516	\$0.90			3/8"	5/16"
A3838	\$0.50	A3838P	\$0.68	3/8"	3/8"
A3812	\$0.50	A3812P	\$0.68	3/8"	1/2"
A3858	\$0.50	A3858P	\$0.68	3/8"	5/8"
A3834	\$0.63	A3834P	\$0.75	3/8"	3/4"
A1214	\$0.54	A1214P	\$0.70	1/2"	1/4"
A1238	\$0.55	A1238P	\$0.71	1/2"	3/8"
A1212	\$0.56	A1212P	\$0.69	1/2"	1/2"
A1258	\$0.60	A1258P	\$0.72	1/2"	5/8"
A1234	\$0.70	A1234P	\$0.75	1/2"	3/4"
A1210	\$0.92	A1210P	\$0.99	1/2"	1"
A12114	\$4.90	A12114P	\$5.36	1/2"	1-1/4"
A3414	\$0.87	A3414P	\$0.87	3/4"	1/4"
A3438	\$0.63	A3438P	\$0.74	3/4"	3/8"
A3412	\$0.64	A3412P	\$0.75	3/4"	1/2"
A3458	\$1.03	A3458P	\$1.03	3/4"	5/8"
A3434	\$0.70	A3434P	\$0.72	3/4"	3/4"
A3410	\$0.87	A3410P	\$0.88	3/4"	1"
A34114	\$1.69	A34114P	\$1.86	3/4"	1-1/4"
A1038	\$0.89	A1038P	\$0.89	1"	3/8"
A1012	\$0.87	A1012P	\$0.88	1"	1/2"
A1058	\$0.88	A1058P	\$0.88	1"	5/8"
A1034	\$0.89	A1034P	\$0.89	1"	3/4"
A1010	\$0.98	A1010P	\$0.99	1"	1"
A1114	\$2.04	A1114P	\$2.18	1"	1-1/4"
A11434	\$2.64	A11434P	\$2.86	1-1/4"	3/4"
A1141	\$2.18	A1141P	\$2.30	1-1/4"	1"
A114	\$2.05	A114P	\$2.22	1-1/4"	1-1/4"
A114112	\$2.26	A114112P	\$2.35	1-1/4"	1-1/2"
A1121	\$2.43	A1121P	\$2.51	1-1/2"	1"
A112	\$2.27	A112P	\$2.40	1-1/2"	1-1/2"
A112114	\$2.38	A112114P	\$2.45	1-1/2"	1-1/4"
A112200	\$7.08	A112200P	\$7.59	1-1/2"	2"
A200112	\$6.00	A200112P	\$6.24	2"	1-1/2"
A200	\$3.07	A200P	\$3.04	2"	2"

90 Degree Elbow

Use in conjunction with a hose clamp and quality thread sealant.

PART #				THREAD	HOSE BARB
NYLON	PRICE ea.	POLY	PRICE ea.	Male NPT x	HOSE BARB
EL18316	\$1.29			1/8"	3/16"
EL1814	\$0.63	EL1814P	\$0.67	1/8"	1/4"
EL1838	\$1.40			1/8"	3/8"
EL1414	\$0.60	EL1414P	\$0.66	1/4"	1/4"
EL14516	\$1.32			1/4"	5/16"
EL1438	\$0.61	EL1438P	\$0.68	1/4"	3/8"
EL1412	\$0.69	EL1412P	\$0.70	1/4"	1/2"
EL1458	\$0.87	EL1458P	\$0.87	1/4"	5/8"
EL3814	\$0.72	EL3814P	\$0.72	3/8"	1/4"
EL38516	\$1.45			3/8"	5/16"
EL3838	\$0.77	EL3838P	\$0.76	3/8"	3/8"
EL3812	\$0.77	EL3812P	\$0.76	3/8"	1/2"
EL3858	\$0.81	EL3858P	\$0.80	3/8"	5/8"
EL1214	\$1.53	EL1214P	\$1.63	1/2"	1/4"
EL1238	\$0.81	EL1238P	\$0.80	1/2"	3/8"
EL1212	\$0.82	EL1212P	\$0.81	1/2"	1/2"
EL1258	\$1.01	EL1258P	\$1.00	1/2"	5/8"
EL1234	\$1.07	EL1234P	\$1.07	1/2"	3/4"
EL3414	\$1.70	EL3414P	\$1.69	3/4"	1/4"
EL3438	\$0.92	EL3438P	\$0.93	3/4"	3/8"
EL3412	\$0.97	EL3412P	\$0.97	3/4"	1/2"
EL3458	\$1.03	EL3458P	\$1.03	3/4"	5/8"
EL3434	\$1.10	EL3434P	\$1.10	3/4"	3/4"
EL3410	\$1.14	EL3410P	\$1.14	3/4"	1"
EL1038	\$1.09	EL1038P	\$1.08	1"	3/8"
EL1012	\$1.09	EL1012P	\$1.08	1"	1/2"
EL1058	\$1.17	EL1058P	\$1.16	1"	5/8"
EL1034	\$1.23	EL1034P	\$1.23	1"	3/4"
EL1010	\$1.34	EL1010P	\$1.34	1"	1"
EL1114	\$2.90	EL1114P	\$2.93	1"	1-1/4"
EL11434	\$2.70	EL11434P	\$2.68	1-1/4"	3/4"
EL1141	\$2.31	EL1141P	\$2.40	1-1/4"	1"
EL114	\$2.48	EL114P	\$2.51	1-1/4"	1-1/4"
EL114112	\$5.00	EL114112P	\$5.03	1-1/4"	1-1/2"
EL112	\$3.19	EL112P	\$3.16	1-1/2"	1-1/2"
EL200	\$4.21	EL200P	\$4.18	2"	2"



90 Degree Elbow

Use in conjunction with a hose clamp and quality thread sealant.

PART #				THREAD	HOSE BARB
NYLON	PRICE ea.	POLY	PRICE ea.	Female NPT x	HOSE BARB
EL1212F	\$1.25	EL1212FP	\$1.14	1/2"	1/2"
EL3412F	\$1.25	EL3412FP	\$1.34	3/4"	1/2"
EL3434F	\$1.52	EL3434FP	\$1.63	3/4"	3/4"



Straight Hose Mender

Used in fluid plumbing applications requiring the connection of two hoses. Commonly called a hose splice fitting or a shim fitting.

PART #				BARB 1	BARB 2
NYLON	PRICE ea.	POLY	PRICE ea.	HOSE BARB x	HOSE BARB
SHM1800	\$0.51	SHM1800P	\$0.64	1/8"	1/8"
SHM3160	\$0.53	SHM3160P	\$0.65	3/16"	3/16"
SHM1418	\$0.69			1/4"	1/8"
SHM14316	\$0.69			1/4"	3/16"
SHM1400	\$0.45	SHM1400P	\$0.65	1/4"	1/4"
SHM5160	\$0.59	SHM5160P	\$0.65	5/16"	5/16"
SHM3800	\$0.50	SHM3800P	\$0.66	3/8"	3/8"
SHM3814	\$0.63	SHM3814P	\$0.95	3/8"	1/4"
SHM1214	\$0.70	SHM1214P	\$0.72	1/2"	1/4"
SHM1200	\$0.64	SHM1200P	\$0.68	1/2"	1/2"
SHM1238	\$0.53	SHM1238P	\$0.67	1/2"	3/8"
SHM1258	\$0.72	SHM1258P	\$0.72	1/2"	5/8"
SHM5800	\$0.72	SHM5800P	\$0.72	5/8"	5/8"
SHM3412	\$1.87			3/4"	1/2"
SHM3400	\$0.81	SHM3400P	\$0.80	3/4"	3/4"
SHM1000	\$0.96	SHM1000P	\$0.96	1"	1"
SHM114	\$1.56	SHM114P	\$1.88	1-1/4"	1-1/4"
SHM112	\$3.24	SHM112P	\$3.28	1-1/2"	1-1/2"
SHM200	\$6.37	SHM200P	\$6.74	2"	2"



Tee Adapter

Used in fluid plumbing applications requiring a connection of two hoses to a Female NPT fitting and a hose.

PART #				THREAD	HOSE BARB
NYLON	PRICE ea.	POLY	PRICE ea.	Male NPT x	HOSE BARB
MT1234	\$1.35	MT1234P	\$1.78	1/2"	3/4"
MT3438	\$1.27	MT3438P	\$1.69	3/4"	3/8"
MT3412	\$1.32	MT3412P	\$1.75	3/4"	1/2"
MT3434	\$1.44	MT3434P	\$1.85	3/4"	3/4"
MT1038	\$1.38	MT1038P	\$1.79	1"	3/8"
MT1012	\$1.43	MT1012P	\$1.84	1"	1/2"
MT1034	\$1.55	MT1034P	\$1.97	1"	3/4"



Elbow Barb

Use in conjunction with a hose clamp.

PART #				BARB 1	BARB 2
NYLON	PRICE ea.	POLY	PRICE ea.	HOSE BARB x 90 DEGREE	HOSE BARB
EB1414	\$1.12	EB1414P	\$1.41	1/4"	1/4"
EB3838	\$1.01	EB3838P	\$1.01	3/8"	3/8"
EB1212	\$0.72	EB1212P	\$0.73	1/2"	1/2"
EB5858	\$1.17	EB5858P	\$1.15	5/8"	5/8"
EB3434	\$0.93	EB3434P	\$1.01	3/4"	3/4"
EB1010	\$2.65			1"	1"
EB114	\$3.76	EB114P	\$3.99	1-1/4"	1-1/4"
EB112	\$3.89	EB112P	\$3.99	1-1/2"	1-1/2"
EB200	\$7.47	EB200P	\$7.43	2"	2"



Insert Tee

Use in conjunction with a hose clamp.

PART #				BARB 1	BARB 2	BARB 3
NYLON	PRICE ea.	POLY	PRICE ea.			
T18	\$1.21	T18P	\$1.27	1/8"	1/8"	1/8"
T3160	\$1.34			3/16"	3/16"	3/16"
T14	\$0.90	T14P	\$1.28	1/4"	1/4"	1/4"
T38	\$0.95	T38P	\$1.32	3/8"	3/8"	3/8"
T3812	\$0.99	T3812P	\$1.35	1/2"	1/2"	3/8"
T12	\$0.98	T12P	\$1.32	1/2"	1/2"	1/2"
T58	\$1.05	T58P	\$1.38	5/8"	5/8"	5/8"
T3412	\$1.05	T3412P	\$1.38	1/2"	1/2"	3/4"
T34	\$1.24	T34P	\$1.38	3/4"	3/4"	3/4"
T100	\$2.16	T100P	\$2.15	1"	1"	1"
T114	\$3.16	T114P	\$3.15	1-1/4"	1-1/4"	1-1/4"
T112	\$3.74	T112P	\$3.77	1-1/2"	1-1/2"	1-1/2"
T200	\$8.66	T200P	\$8.60	2"	2"	2"



Straight Adapter

Used in fluid plumbing applications requiring straight connection to a Male fitting and a hose.

PART #				THREAD	HOSE BARB
NYLON	PRICE ea.	POLY	PRICE ea.	Female NPT x HOSE BARB	
AF1414	\$1.47			1/4"	1/4"
AF1438	\$3.47			1/4"	3/8"
AF3838	\$3.96	AF3838P	\$4.17	3/8"	3/8"
AF3812	\$3.45	AF3812P	\$3.70	3/8"	1/2"
AF1212	\$1.21	AF1212P	\$1.30	1/2"	1/2"
AF1238	\$1.21	AF1238P	\$1.30	1/2"	3/8"
		AF1234P	\$3.36	1/2"	3/4"
AF3412	\$4.07	AF3412P	\$4.02	3/4"	1/2"
AF3458	\$1.28	AF3458P	\$1.34	3/4"	5/8"
AF3434	\$1.28	AF3434P	\$1.34	3/4"	3/4"



Cross Barb

Used in fluid applications requiring the connection of four hoses. Commonly called a junction fitting.

PART #				HOSE BARB
NYLON	PRICE ea.	POLY	PRICE ea.	
X14	\$1.01	X14P	\$1.10	1/4"



Flat Seat Hose Barb

Used with swivel nut B3400 and washer W406 shown in this catalog. Combining the three pieces allows for a swivel connection of common size hoses.

PART #				HOSE BARB
NYLON	PRICE ea.	POLY	PRICE ea.	BARB x FLAT SEAT
C1800	\$0.65	C1800P	\$0.68	1/8"
C1400	\$0.49	C1400P	\$0.67	1/4"
C3800	\$0.48	C3800P	\$0.68	3/8"
C1200	\$0.49	C1200P	\$0.68	1/2"
C5800	\$0.48	C5800P	\$0.68	5/8"
C3400	\$0.49	C3400P	\$0.69	3/4"



Reducer Bushing

Used in fluid plumbing applications to connect a Female NPT thread to a reduced size of a Male NPT fitting.

PART #				THREAD	
NYLON	PRICE ea.	POLY	PRICE ea.	Male NPT x	Female NPT
RB1418	\$0.87	RB1418P	\$0.99	1/4"	1/8"
RB3818	\$0.90	RB3818P	\$1.01	3/8"	1/8"
RB3814	\$0.88	RB3814P	\$0.99	3/8"	1/4"
RB1218	\$1.37	RB1218P	\$1.42	1/2"	1/8"
RB1214	\$0.93	RB1214P	\$1.03	1/2"	1/4"
RB1238	\$0.91	RB1238P	\$1.03	1/2"	3/8"
RB3418	\$1.01	RB3418P	\$1.09	3/4"	1/8"
RB3414	\$1.21	RB3414P	\$1.31	3/4"	1/4"
RB3438	\$1.28	RB3438P	\$1.28	3/4"	3/8"
RB3412	\$0.95	RB3412P	\$1.08	3/4"	1/2"
RB1012	\$1.69	RB1012P	\$1.68	1"	1/2"
RB1034	\$1.17	RB1034P	\$1.16	1"	3/4"
RB11434	\$2.09	RB11434P	\$2.22	1-1/4"	3/4"
RB1141	\$2.00	RB1141P	\$2.15	1-1/4"	1"
RB11234	\$2.30	RB11234P	\$2.38	1-1/2"	3/4"
RB1121	\$2.26	RB1121P	\$2.35	1-1/2"	1"
RB112114	\$2.01	RB112114P	\$2.75	1-1/2"	1-1/4"
RB2001	\$4.02	RB2001P	\$4.00	2"	1"
RB200114	\$3.07	RB200114P	\$3.04	2"	1-1/4"
RB200112	\$2.76	RB200112P	\$2.75	2"	1-1/2"
RB300200	\$4.94	RB300200P	\$6.83	3"	2"



Elbow

Used in fluid plumbing applications to connect to Male NPT fittings at 90 degrees.

PART #				THREAD	
NYLON	PRICE ea.	POLY	PRICE ea.	Female NPT x 90 DEGREE	Female NPT
ELF12	\$2.76	ELF12P	\$3.04		1/2"
ELF34	\$3.14	ELF34P	\$3.40		3/4"
ELF100	\$4.46	ELF100P	\$4.60		1"
ELF114	\$6.05	ELF114P	\$6.32		1-1/4"
ELF112	\$7.19	ELF112P	\$7.98		1-1/2"
ELF200	\$10.54	ELF200P	\$10.72		2"



Coupling

Used in fluid plumbing applications to connect two Male NPT fittings.

PART #				THREAD	
NYLON	PRICE ea.	POLY	PRICE ea.	Female NPT	
		FTC1800P	\$3.84	1/8"	
FTC14	\$4.21	FTC14P	\$4.36	1/4"	
FTC38	\$4.21			3/8"	
FTC12	\$2.92	FTC12P	\$3.01	1/2"	
FTC34	\$3.55	FTC34P	\$3.52	3/4"	
FTC3412	\$2.90			3/4" x 1/2"	
FTC100	\$4.03	FTC100P	\$4.01	1"	
FTC114	\$5.67	FTC114P	\$5.62	1-1/4"	
FTC112	\$6.76	FTC112P	\$6.71	1-1/2"	
FTC200	\$9.98	FTC200P	\$9.91	2"	



Plug

Use in conjunction with a hose clamp and quality thread sealant.

PART #				THREAD
NYLON	PRICE ea.	POLY	PRICE ea.	Male NPT x HEX
F1800	\$0.58	F1800P	\$0.64	1/8"
F1400	\$0.63	F1400P	\$0.64	1/4"
F3800	\$0.66	F3800P	\$0.67	3/8"
F1200	\$0.67	F1200P	\$0.68	1/2"
F3400	\$0.71	F3400P	\$0.72	3/4"
F1000	\$0.74	F1000P	\$0.77	1"
F1014	\$1.09	F1014P	\$1.18	1-1/4"
F112	\$3.03	F112P	\$3.10	1-1/2"
F200	\$3.70			2"



Nipple

Used in fluid plumbing application to connect two Female NPT fittings.

PART #				THREAD
NYLON	PRICE ea.	POLY	PRICE ea.	Male NPT x Male NPT
M1800	\$0.58	M1800P	\$0.64	1/8"
M1400	\$0.63	M1400P	\$0.72	1/4"
M3800	\$0.66	M3800P	\$0.75	3/8"
M1200	\$0.68	M1200P	\$0.77	1/2"
M3400	\$0.74	M3400P	\$0.88	3/4"
M1000	\$1.17	M1000P	\$1.29	1"
M1140	\$2.16	M1140P	\$2.20	1-1/4"
M1120	\$2.63	M1120P	\$2.88	1-1/2"
M2000	\$3.78	M2000P	\$4.19	2"



Reducing Nipple

Used in fluid plumbing application to connect two Female NPT fittings.

PART #				THREAD	
NYLON	PRICE ea.	POLY	PRICE ea.	Male NPT x Male NPT	
RM1438	\$0.67	RM1438P	\$0.68	1/4"	3/8"
RM3818	\$0.79			3/8"	1/8"
RM3812	\$0.71	RM3812P	\$0.71	3/8"	1/2"
RM38116	\$0.71	RM38116P	\$0.71	3/8"	11/16" UN
RM12116	\$0.71	RM12116P	\$0.71	1/2"	11/16" UN
RM1214	\$0.67	RM1214P	\$0.70	1/2"	1/4"
RM3438	\$0.69	RM3438P	\$0.72	3/4"	3/8"
RM3412	\$0.71	RM3412P	\$0.74	3/4"	1/2"
RM34116	\$0.76	RM34116P	\$0.79	3/4"	11/16" UN
RM1141	\$1.70	RM1141P	\$2.22	1-1/4"	1"



Tee

Used in fluid plumbing applications requiring the connection of three fittings or pipes all having Male NPT threads.

PART #				THREAD	
NYLON	PRICE ea.	POLY	PRICE ea.	Female NPT	
TT14	\$3.70	TT14P	\$3.85	1/4"	
TT12	\$3.52	TT12P	\$3.97	1/2"	
TT34	\$4.90	TT34P	\$4.93	3/4"	
TT100	\$6.24	TT100P	\$6.48	1"	
TT114	\$8.00	TT114P	\$8.21	1-1/4"	
TT112	\$9.63	TT112P	\$10.09	1-1/2"	
TT200	\$13.17	TT200P	\$13.36	2"	
		TT300P	\$56.14	3"	



Tee with Gauge Port

Used in fluid plumbing applications requiring the connection of three fittings or pipes all having Male NPT threads. Special port extends from center of body for a gauge.

PART #				THREAD	PORT
NYLON	PRICE ea.	POLY	PRICE ea.	Female NPT	
TT1218	\$6.30	TT1218P	\$6.70	1/2"	1/8"
TT1214	\$6.30	TT1214P	\$6.70	1/2"	1/4"
TT3418	\$8.40	TT3418P	\$8.76	3/4"	1/8"
TT3414	\$8.40	TT3414P	\$8.76	3/4"	1/4"
TT10014	\$10.50	TT10014P	\$10.82	1"	1/4"
TT11414	\$11.03			1-1/4"	1/4"
TT11214	\$11.29			1-1/2"	1/4"

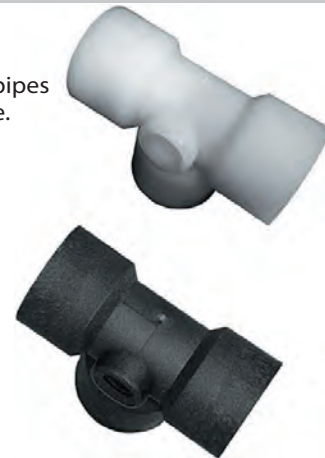

Street Elbow

Used in fluid plumbing applications to connect a Female NPT fitting and a Male NPT at 90 degrees. This fitting is very useful when working space is a minimum.

PART #				THREAD	THREAD
NYLON	PRICE ea.	POLY	PRICE ea.	Male NPT x 90 Degree	Female NPT
SE14	\$2.97	SE14P	\$3.14	1/4"	1/4"
SE38	\$3.02	SE38P	\$3.19	3/8"	3/8"
SE12	\$3.08	SE12P	\$3.24	1/2"	1/2"
SE1234	\$3.20	SE1234P	\$3.35	1/2"	3/4"
SE34	\$3.57	SE34P	\$3.71	3/4"	3/4"
SE100	\$4.69	SE100P	\$4.78	1"	1"
SE114	\$6.44	SE114P	\$6.57	1-1/4"	1-1/4"
SE112	\$7.93	SE112P	\$8.03	1-1/2"	1-1/2"
SE200	\$8.45	SE200P	\$8.55	2"	2"



Adapter

Garden Hose fitting used to connect a Female GHT fitting to a Male NPT fitting.

PART #				THREAD	THREAD
NYLON	PRICE ea.	POLY	PRICE ea.	3/4" Male GHT x Female NPT	
G3412	\$1.92	G3412P	\$2.10	3/4"	1/2"
G3434	\$1.90	G3434P	\$2.08	3/4"	3/4"



Adapter

Garden Hose fitting used to connect a Female NPT fitting to a Male GHT fitting.

PART #				THREAD	THREAD
NYLON	PRICE ea.	POLY	PRICE ea.	Male NPT x 3/4" Female GHT	
H3434	\$1.88	H3434P	\$2.06	3/4"	3/4"



Adapter

Garden Hose fitting used to connect two female fittings.

PART #				THREAD	THREAD
NYLON	PRICE ea.	POLY	PRICE ea.	Male GHT x Male NPT	
E3412	\$0.71	E3412P	0.74	3/4"	1/2"
E3438	\$1.28	E3438P	\$1.40	3/4"	3/8"
E3434	\$0.70	E3434P	\$0.87	3/4"	3/4"
EE3434	\$0.92	EE3434P	\$0.95	3/4"	3/4" Male GHT



Adapter

Garden Hose fitting used to connect a Female GHT to a Male GHT fitting. Female GHT requires a W 406 washer.

PART #				THREAD	THREAD
NYLON	PRICE ea.	POLY	PRICE ea.	3/4" Male GHT x 3/4" Female GHT	
I3434	\$1.86	I3434P	\$2.05	3/4"	3/4"



Coupling

Garden Hose fitting used to connect a Male GHT to a Male NPT fitting. Female GHT requires a W 406 washer.

PART #				THREAD	THREAD
NYLON	PRICE ea.	POLY	PRICE ea.	3/4" Female GHT x Female NPT	
J3412	\$1.91	J3412P	\$2.09	3/4"	1/2"





Cap

Female thread x Closed end. Requires W 406 washer.

PART #				THREAD
NYLON	PRICE ea.	POLY	PRICE ea.	Female GHT & Female NPS
N3400	\$0.77	N3400P	\$0.77	3/4" Female GHT
N3400F	\$0.77	N3400FP	\$0.77	3/4" Female NPS



Plug

Garden Hose fitting used to plug off a Female GHT fitting.

PART #				THREAD
NYLON	PRICE ea.	POLY	PRICE ea.	3/4" Male GHT x HEX
F3400GHT	\$0.61	F3400GHTP	\$0.72	3/4"

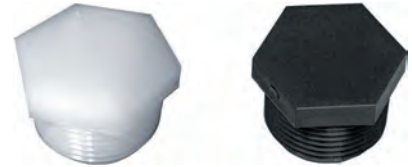

Tee Adapter

Garden Hose fitting used to connect 3/4" Female GHT fitting to two hoses.

PART #				THREAD	HOSE BARB
NYLON	PRICE ea.	POLY	PRICE ea.	Male GHT x HOSE BARB	
MT3438G	\$1.25	MT3438GP	\$1.68	3/4"	3/8"
MT3412G	\$1.32	MT3412GP	\$1.75	3/4"	1/2"
MT3434G	\$1.44	MT3434GP	\$1.85	3/4"	3/4"



Adapter

Garden Hose fitting used to connect 3/4" Female GHT fitting to a hose.

PART #				THREAD	HOSE BARB
NYLON	PRICE ea.	POLY	PRICE ea.	3/4" Male GHT x Hose Barb	
D3414	\$0.67	D3414P	\$0.74	3/4"	1/4"
D3438	\$0.69	D3438P	\$0.74	3/4"	3/8"
D3412	\$0.70	D3412P	\$0.79	3/4"	1/2"
D3458	\$0.72	D3458P	\$0.79	3/4"	5/8"
D3434	\$0.79	D3434P	\$0.78	3/4"	3/4"
D3410	\$0.87	D3410P	\$0.87	3/4"	1"



Elbow

Garden Hose fitting used to connect 3/4" Female GHT to a hose at 90 degrees.

PART #				THREAD	HOSE BARB
NYLON	PRICE ea.	POLY	PRICE ea.	3/4" Male GHT x 90 degree	
EL3438G	\$0.92	EL3438GP	\$0.93	3/4"	3/8"
EL3412G	\$0.92	EL3412GP	\$0.92	3/4"	1/2"
EL3458G	\$1.03	EL3458GP	\$1.03	3/4"	5/8"
EL3434G	\$1.07	EL3434GP	\$1.07	3/4"	3/4"
EL3410G	\$1.09	EL3410GP	\$1.08	3/4"	1"



Reducing Nipple

Garden Hose fitting used to connect two Female PT fittings.

PART #				THREAD	
NYLON	PRICE ea.	POLY	PRICE ea.	MALE GHT X MALE	
RM34116G	\$0.81	RM34116GP	\$0.80	3/4"	11/16" UN



Swivel Nut

Garden Hose fitting used to connect a hose using a C series fitting with a washer.

PART #				THREAD	
NYLON	PRICE ea.	POLY	PRICE ea.	3/4" Female GHT	
B3400	\$0.54	B3400P	\$0.70	3/4" Female GHT	
B3400F	\$0.57	B3400FP	\$0.70	3/4" Female NPS	



Washers

Vinyl Garden Hose washer. Used with all 3/4" Female GHT fittings in this catalog.

PART #	PRICE ea.	DESCRIPTION
W406	\$0.12	Vinyl Garden Hose Washer
W40650S	\$1.09	Vinyl Garden Hose Washer with 50 mesh screen



3-Piece Barb Assembly

Garden Hose fitting with swivel connection. Used to connect 3/4" Female GHT to a hose. Washer is vinyl in both nylon and poly assemblies.

PART #				SWIVEL	HOSE BARB	WASHER
NYLON	PRICE ea.	POLY	PRICE ea.			
B3414W	\$1.52	B3414WP	\$1.55	B3400	1/4"	W 406
B3438W	\$1.51	B3438WP	\$1.56	B3400	3/8"	W 406
B3412W	\$1.52	B3412WP	\$1.85	B3400	1/2"	W 406
B3458W	\$1.51	B3458WP	\$1.83	B3400	5/8"	W 406
B3434W	\$1.52	B3434WP	\$1.85	B3400	3/4"	W 406



Garden Hose Shutoff Valves

Single and double garden hose valves with 3/4" GHT. 100 PSI maximum operating pressure. ABS construction.

PART #	PRICE ea.	DESCRIPTION
G3434V	\$6.40	3/4" Female GHT (inlet) x 3/4" Male GHT (1 outlet)
G3434YV	\$8.90	3/4" Female GHT (inlet) x 3/4" Male GHT (2 outlets)





Hex Nut

Used to lock nozzle fitting in this catalog to Boom Clamp fittings.

PART #				THREAD
NYLON	PRICE ea.	POLY	PRICE ea.	
N1116	\$0.32	N1116P	\$0.44	11/16" Female UN



Straight Adapter

Thread 11/16" male UN x hose barb, nut included. Used on the terminating ends of spray boom or a boom using a manifold.

PART #				HOSE BARB SIZE
NYLON	PRICE ea.	POLY	PRICE ea.	
3838D	\$0.92	3838DP	\$0.93	3/8"
3812D	\$0.96	3812DP	\$0.96	1/2"
3834D	\$1.18	3834DP	\$1.17	3/4"

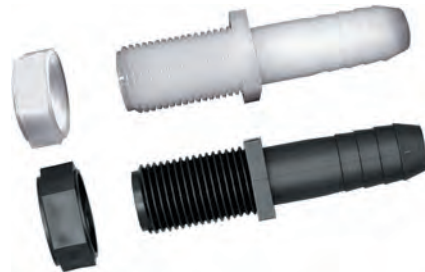

Elbow

Thread 11/16" male UN x hose barb, nut included. Used on the terminating ends of spray boom.

PART #				HOSE BARB SIZE
NYLON	PRICE ea.	POLY	PRICE ea.	
NTL38	\$1.21	NTL38P	\$1.22	3/8"
NTL12	\$1.27	NTL12P	\$1.27	1/2"
NTL34	\$1.32	NTL34P	\$1.32	3/4"



Cross

Thread 11/16" male UN x hose barb, nut included. Used in the center of boom sections as a main feed line.

PART #				HOSE BARB SIZE
NYLON	PRICE ea.	POLY	PRICE ea.	
T38C	\$1.12	T38CP	\$1.36	3/8"
T12C	\$1.32	T12CP	\$1.40	1/2"
T34C	\$1.41	T34CP	\$1.49	3/4"



Tee

Thread 11/16" male UN x hose barb, nut included. Used between the main feed lines and termination end of boom sections.

PART #				HOSE BARB SIZE
NYLON	PRICE ea.	POLY	PRICE ea.	
NTT38	\$1.31	NTT38P	\$1.32	3/8"
NTT12	\$1.34	NTT12P	\$1.34	1/2"
NTT34	\$1.63	NTT34P	\$1.62	3/4"



Spray Tip Blank

Blanks for Boom Drops, used when changing row spacing.

PART #				THREAD
NYLON	PRICE ea.	POLY	PRICE ea.	
8028	\$0.42	8028P	\$0.46	11/16" Female UN



Male Adapter

Allows 1/4" female boom drops to be converted to accept 11/16" UN swivel cap.

PART #				THREAD
NYLON	PRICE ea.	POLY	PRICE ea.	
NB164	\$0.58	NB164P	\$0.67	11/16" Male UN x 1/4" Male NPT
NB168	\$0.61			11/16" Male UN x 1/8" Male NPT



Boom Clamp

Boom Clamps fit all nozzle thread fittings in this catalog.

PART #				SIZE
NYLON	PRICE ea.	POLY	PRICE ea.	
B111	\$1.60	B111P	\$1.75	Fits 1" Round or Square Tubing
B11114	\$1.70	B11114P	\$1.86	Fits 1 1/4" Round or Square Tubing



Female Adapter

Allows 11/16" UN nozzle fittings in this catalog to be converted to accept 1/4" Male NPT flood tips.

PART #				THREAD
NYLON	PRICE ea.	POLY	PRICE ea.	
1116A	\$1.06	1116AP	\$1.06	11/16" Female UN x 1/4" Female NPT



Swivel Nut

For use with Male Adapter and all nozzle fittings in this catalog. Fastens spray tips to nozzle fittings.

PART #				THREAD
NYLON	PRICE ea.	POLY	PRICE ea.	
8027	\$0.41	8027P	\$0.46	11/16" Female UN
8027W	\$0.61	8027WP	\$0.62	



Metering Barb

Used to run a line from spray boom to a gauge for monitoring boom pressure. Connects to Male Adapter and all nozzle fittings in this catalog with a 8027 swivel nut.

PART #				BARB SIZE
NYLON	PRICE ea.	POLY	PRICE ea.	
K8414	\$0.46	K8414P	\$0.46	1/4"
K8438	\$0.49	K8438P	\$0.49	3/8"
K8412	\$0.51	K8412P	\$0.52	1/2"



Spray Components



Range of Product

Whether you're landscaping or out on the back 40, Green Leaf has the top quality fluid flow products and component parts to help you get the job done.

Attributes

Our extensive product line is focused on fluid flow & related components. This means Green Leaf is able to meet our customers complete needs.

Position

By trusting Green Leaf's 40 years of experience, you can be assured that your fluid flow needs are not only met, but places you in the position to succeed.

Your Success is Our Success!



Pressure Gauges

Standard Gauge

PART #	PRICE ea.	DESCRIPTION
SG060	\$8.19	2" Gauge, 60 PSI
SG100	\$8.19	2" Gauge, 100 PSI
SG200	\$8.19	2" Gauge, 200 PSI
SG400	\$8.19	2" Gauge, 400 PSI
SG1004	\$22.01	4" Gauge, 100 PSI

Liquid Gauge

PART #	PRICE ea.	DESCRIPTION
LG100	\$16.80	2-1/2" Liquid Filled, 100 PSI
LG200	\$16.80	2-1/2" Liquid Filled, 200 PSI

Ammonia Gauge

PART #	PRICE ea.	DESCRIPTION
AG060	\$17.22	2-1/2" Ammonia, 60 PSI



Steel Boom Clamps

Standard Clamps-Round

PART #	PRICE ea.	DESCRIPTION
B1134R	\$4.00	3/4"
B111R	\$4.00	1"

Standard Clamps-Square

PART #	PRICE ea.	DESCRIPTION
B111SQ	\$4.00	1"
B11114SQ	\$4.00	1-1/4"

Quick Clamps-Round

PART #	PRICE ea.	DESCRIPTION
BQ1134R	\$5.61	3/4"
BQ111R	\$5.61	1"
BQ11114R	\$5.61	1-1/4"

Quick Clamps-Square

PART #	PRICE ea.	DESCRIPTION
BQ1134SQ	\$5.61	3/4"
BQ111SQ	\$5.61	1"
BQ11114SQ	\$5.78	1-1/4"
BQ11112SQ	\$5.61	1-1/2"

DESCRIPTION	PART #	PRICE ea.	
Quick fit adapter, 1/4", nylon, QD adapter	Y8230021	\$4.10	1/4"



DESCRIPTION	PART #	PRICE ea.	
Dry boom nozzle body, 3/8", elbow barb	Y8231001	\$4.80	3/8"
Dry boom nozzle body, 1/2", elbow barb	Y8231003	\$4.80	1/2"
Dry boom nozzle body, 3/4", elbow barb	Y8231005	\$4.80	3/4"



DESCRIPTION	PART #	PRICE ea.	
Dry boom nozzle body, 3/8", tee barb	Y8231007	\$4.80	3/8"
Dry boom nozzle body, 1/2", tee barb	Y8231009	\$4.80	1/2"
Dry boom nozzle body, 3/4", tee barb	Y8231011	\$4.80	3/4"



DESCRIPTION	PART #	PRICE ea.	
Dry boom nozzle body, 3/8", cross barb	Y8231013	\$4.80	3/8"
Dry boom nozzle body, 1/2", cross barb	Y8231015	\$4.80	1/2"
Dry boom nozzle body, 3/4", cross barb	Y8231017	\$4.80	3/4"



DESCRIPTION	PART #	PRICE ea.	
Single hose barb for Rotary to dry boom, 1/2", for .41" port	Y8294014	\$1.81	1/2"
Single hose barb for Rotary to dry boom, 3/4", for .41" port	Y8294015	\$1.81	3/4"
Single hose barb for Rotary to dry boom, 3/4" Hose ID, 1" Pipe OD, for .41" port	Y8294028	\$2.31	3/4"
Single hose barb for Rotary to dry boom, 1", for .41" port	Y8294029	\$2.31	1"



DESCRIPTION	PART #	PRICE ea.	
Double hose barb for Rotary to dry boom, 1/2", for .41" port	Y8294017	\$1.81	1/2"
Double hose barb for Rotary to dry boom, 3/4", for .41" port	Y8294018	\$1.81	3/4"
Double hose barb for Rotary to dry boom, 3/4" Hose ID, 1" Pipe OD, for .41" port	Y8294030	\$2.31	3/4"
Double hose barb for Rotary to dry boom, 1", for .41" port	Y8294031	\$2.31	1"



BOOM COMPONENTS

DESCRIPTION	PART #	PRICE ea.	
Dry boom nozzle body, 3/8", elbow, top diaphragm	Y8235019	\$10.39	3/8"
Dry boom nozzle body, 1/2", elbow, top diaphragm	Y8235021	\$10.39	1/2"
Dry boom nozzle body, 3/4", elbow, top diaphragm	Y8235023	\$10.39	3/4"



DESCRIPTION	PART #	PRICE ea.	
Dry boom nozzle body, 3/8", tee, top diaphragm	Y8235025	\$10.39	3/8"
Dry boom nozzle body, 1/2", tee, top diaphragm	Y8235027	\$10.39	1/2"
Dry boom nozzle body, 3/4", tee, top diaphragm	Y8235029	\$10.39	3/4"



DESCRIPTION	PART #	PRICE ea.	
Dry boom nozzle body, 3/8", cross barb, side diaphragm	Y8235013	\$10.23	3/8"
Dry boom nozzle body, 1/2", cross barb, side diaphragm	Y8235015	\$12.38	1/2"
Dry boom nozzle body, 3/4", cross barb, side diaphragm	Y8235017	\$12.38	3/4"



DESCRIPTION	PART #	PRICE ea.	
1/2" pipe wet boom nozzle body, diaphragm, EPDM, .39"	Y8234007	\$9.27	1/2"
3/4" pipe wet boom nozzle body, diaphragm, EPDM, .39"	Y8234009	\$10.78	3/4"
1" pipe wet boom nozzle body, diaphragm, EPDM, .39"	Y8234051	\$10.80	1"



DESCRIPTION	PART #	PRICE ea.	
Rotary nozzle body, 3 way, diaphragm right, wet boom, EPDM, .39" port	Y8244138	\$23.98	1"





Y8253040



Y8253050



YG00002020

Winged Bayonet Caps

DESCRIPTION	PART #	PRICE ea.	
Winged bayonet caps, ID, IS, DF, FL, 10 mm across flats	Y8253049	\$1.47	black
Winged bayonet caps, TR, ITR, poly FT, round	Y8253050	\$1.47	black
Winged bayonet caps, poly FT self aligning	Y8253051	\$1.47	black
Winged bayonet caps, closed	Y8253040	\$1.47	black
Winged bayonet caps, 8 mm/10 mm Universal	Y8253080	\$1.47	black
Replacement W B Cap gaskets	YG00002020	\$1.47	black



Y8139002



Y8139003



Y8139011

Spray Tip Filters

DESCRIPTION	PART #	PRICE ea.	
Nozzle filters, poly, stainless screen, 50 mesh	Y8139002	\$1.51	blue
Nozzle filters, poly, stainless screen, 100 mesh	Y8139003	\$1.51	green
Nozzle filters, poly, 50 mesh, stainless screen, w/ check valve	Y8139004	\$1.77	blue
Nozzle filters, poly, 100 mesh, stainless screen, w/ check valve	Y8139005	\$1.77	green

Nozzle filters, brass, 50 mesh, stainless screen, w/ check valve	Y8139009	\$6.15	brass
Nozzle filters, brass, 100 mesh, stainless screen, w/ check valve	Y8139010	\$6.15	brass
Nozzle filters, brass, stainless screen, 50 mesh	Y8139011	\$5.41	brass
Nozzle filters, brass, stainless screen, 100 mesh	Y8139012	\$5.41	brass

2-Way Solenoid Valves

Large Solenoid Valve

12-Volt DC Electric Boom Shutoff Valves have a 3/4" NPT Female inlet, 3/4" NPT male bypass outlet and a 1/2" NPT female boom outlet. This direct operating valve is designed for 100 PSI maximum operating pressure and 10GPM. (only 5 PSI pressure is lost @ 10 GPM)

- Draws 2 amps per valve at 12 volts.
- Viton seals and o-rings.
- Wetted parts are made of 430 SS and glass filled nylon.

PART #	PRICE ea.	DESCRIPTION
2500B1	\$199.99	Solenoid Shutoff Valve, Single
2352	\$48.50	Repair Kit for 2500B-1 Solenoid Valve



2500B1

Manual Valve

2750 Manual Valve
This manual valve has a 3/4" NPT male and female inlet and bypass and a 1/2" NPT female boom outlet.

- 0-10 GPM, 175 PSI
- Viton Seals and o-rings.
- Wetted parts are made of 302 SS and glass filled nylon.

**The 2750 is a manual valve with a 1/4" NPT pump pressure point that needs to be drilled to function.*

PART #	PRICE ea.	DESCRIPTION
2750	\$116.78	Manual Shutoff Valve



2750

Wiring Harnesses

- 96" wiring harness with on/off switch & 2-pin connector
- 12 volt

PART #	PRICE ea.	DESCRIPTION
WH101CA	\$10.82	12V with car adapter connection 7 amp tube fuse — 20 gauge wire
WH102BC	\$10.82	12V with 15 amp battery clips no fuse — 20 gauge wire
WH104	\$23.29	12V with car adapter & 15 amp battery clip 7 amp blade fuse — 18 gauge wire
WH105	\$26.26	12V with car adapter & 15 amp battery clip 15 amp mini blade fuse — 16 gauge wire
WH96EX	\$15.40	12V - 96" Wiring Harness Extension 18 gauge wire



WH101CA



WH102BC

Suction Filters



PART #	PRICE ea.	DESCRIPTION
600146	\$1.84	Suction Filter for detergents; 3/8" barb



Hose Drop

PART #	PRICE ea.	DESCRIPTION
Y8251000	\$15.80	Hose Drop Tube Assembly; 15"; Bayonet Connection
Y8251002	\$15.92	Hose Drop Tube Assembly; 24"; Bayonet Connection

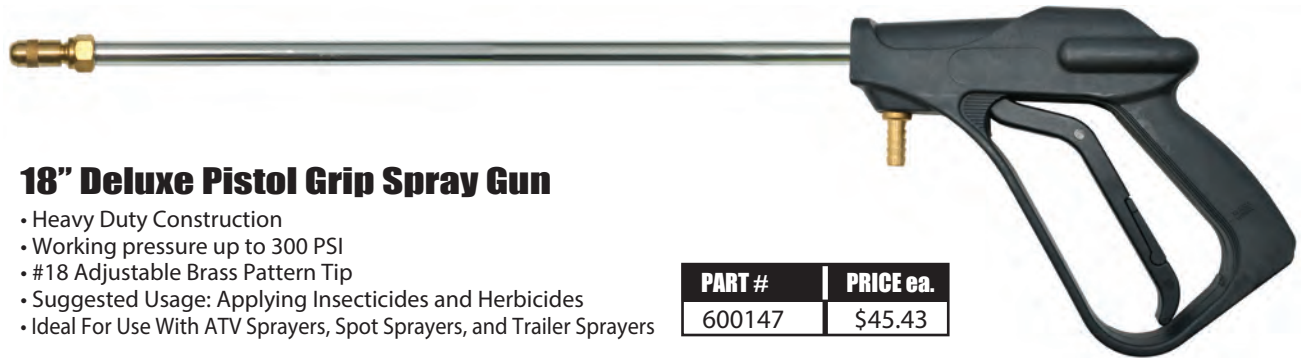

18" Deluxe Pistol Grip Spray Gun

- Heavy Duty Construction
- Working pressure up to 300 PSI
- #18 Adjustable Brass Pattern Tip
- Suggested Usage: Applying Insecticides and Herbicides
- Ideal For Use With ATV Sprayers, Spot Sprayers, and Trailer Sprayers

PART #	PRICE ea.
600147	\$45.43



Spot Spray Gun

- Spray Gun with #18 orifice
- 18" overall length
- 3/8" hose barb connection
- Filter in handle
- Working pressure 200 PSI

PART #	PRICE ea.
600227	\$21.76



String Wing

- Wick arrangement gives a double wipe which means an even application rate and a better kill.
- 5' sections help reduce wicks from drying out when applying on uneven ground where the wick bar is constantly tilted.
- Build any length applicator you want with the "String Wing", the convenient 5' sections allow you to build 10', 15', 20', etc. sections.
- The special design of alternating wicks on the end cap means when you put "String Wings" end to end you get full swath coverage; (No spots missed).
- Each "String Wing" has its own 1 1/4" fill opening and a breather to prevent vapor locking or pressure surges due to weather temperatures.

PART #	PRICE ea.
SW	\$201.53

**Use with Your
Choice of Herbicide
& Wick Away
Unwanted Weeds**



Bucket Mount

PART #	PRICE ea.
SWBM	\$150.64

NEW



Reece Hitch Mount

Front or Rear Mount for 2" Receivers

PART #	PRICE ea.
SWHM	\$167.38

NEW

*STRING WING SOLD SEPARATELY



EG3434

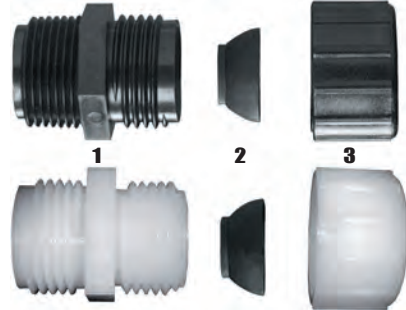

Rope Wick Fitting

REF#	PART #				DESCRIPTION
	NYLON	PRICE ea.	POLY	PRICE ea.	
1	E3434	\$0.70	E3434P	\$0.87	3/4" Male GHT X 3/4" MPT Nylon
2	W407	\$0.50			Cone Washer
3	B3450	\$0.51	B3450P	\$0.69	3/4" Female GHT x 1/2" opening
3	B3458	\$0.51	B3458P	\$0.69	3/4" Female GHT x 5/8"
1, 2, 3	E3434C	\$2.25	E3434CP	\$2.44	1ea. E3434, B3450 & W407
EG3434	EG3434	\$1.28	Glue on Body. Designed to fit over 3" schedule 40 PVC pipe only.		



Wick Replacement Kit

PART #	PRICE ea.	DESCRIPTION
WK1	\$89.50	Wick replacement for String Wing, includes 14 each 18" wicks with 28 each B3450 fittings and W407 cone washers installed.
WK2	\$310.50	Wick Replacement Kit for a 20' wick bar. Parallel wick rows. Includes 50 each 18" wicks with 100 ea. B3450 fittings & W407 cone washers installed.
WK3	\$165.50	Wick Replacement includes 50 each 18" wicks. No fittings or cone washers. Wick ends are heat sealed.
WK4	\$6.25	1 - 18" Wick; 2 - B3450 fittings and 2 - W407 cone washers. Wick ends are heat sealed.
WK5	\$155.50	String Wing Do-It-Yourself Kit - 5ft. Includes 27-EG3434; 2-SW300CAP DWF; 1-WK1; 1-SW1140CAP; 1-M1140; 1-SW Breather
WK10	\$262.50	String Wing Do-It-Yourself Kit - 10ft. Includes 54-EG3434; 2-SW300CAP DWF; 2-WK1; 1-SW1140CAP; 1-M1140; 1-SW Breather
WK15	\$375.50	String Wing Do-It-Yourself Kit - 15ft. Includes 81-EG3434; 2-SW300CAP DWF; 3-WK1; 1-SW1140CAP; 1-M1140; 1-SW Breather
WK20	\$490.50	String Wing Do-It-Yourself Kit - 20ft. Includes 108-EG3434; 2-SW300CAP DWF; 4-WK1; 1-SW1140CAP; 1-M1140; 1-SW Breather

Weed Thief

- Robs garden of unwelcome weeds
- Rids lawn of dandelions
- Cleans fence rows
- Kills weeds in row crops
- Easy to use
- Lightweight 2 1/2 pounds when filled
- Economical

PART #	PRICE ea.
WT1	\$33.20

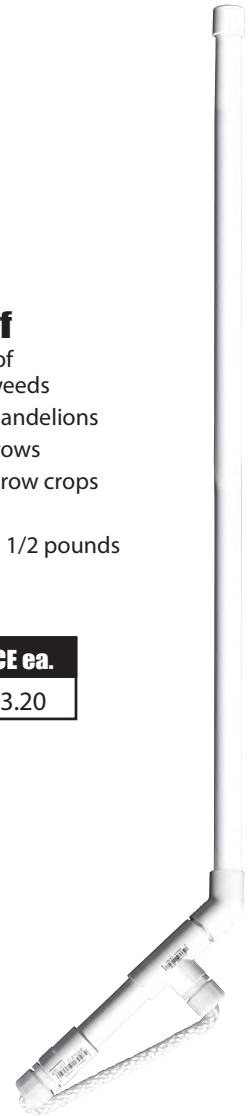

Adapter

This fitting was used in early model rope wick applicators. Requires the use of N1116 Nut and either an "O" ring for wick bar use or a W406 washer if used as a tank fitting. ("O" ring are special order)



PART #				THREAD
NYLON	PRICE ea.	POLY	PRICE ea.	
1116B	\$0.63	1116BP	\$0.79	11/16"

Cone Washer

Used for sealing wick in fitting. Fits 1/2" or 5/8" wick material.

PART #	PRICE ea.
W407	\$0.50



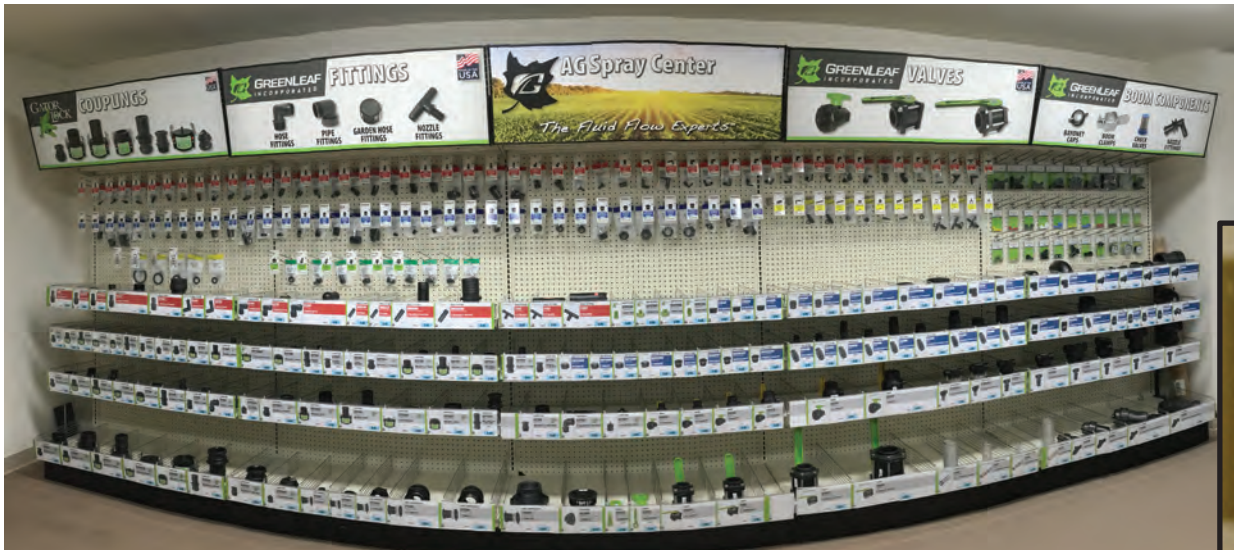

Planograms & Custom Displays

- Planogram Assistance Available
- 4ft. to 20 ft. Options
- Customized to Fit Your Needs

4ft to 20ft Options



Peg Hangers & Bin Strips

- Packaging
- Bagging
- Labeling
- UPC Codes



Ziploc Style Bags Available





GREENLEAF INCORPORATED

*Quality, Service & Commitment...
IS Never Compromised.*

Mission: To work hard, be passionate & enjoy providing superior products while meeting or exceeding our customers' needs & expectations. With effective communication & exceptional service we will build a relationship with our suppliers & customers based on trust and loyalty.

Pledge: It is our promise to adhere to the below principles recognizing our responsibility to our Customer, our People and our Business.

Customer - Green Leaf pledges to bring our expertise in product engineering, manufacturing, distribution and customer service to our diverse line of fluid flow parts and to deliver superior products, accurately and on time while maintaining a fair price.

Employee - Green Leaf pledges to maintain a safe and inviting environment for all employees while providing fair wages and the opportunity to excel and grow. We value honesty, integrity and mutual respect; each person will be considered an individual; we will succeed as a team.

Business - Green Leaf pledges to make a sound profit. We must create reserves, carry on research, develop programs and pay for mistakes. Equipment and machines will need purchased, facilities built and new products launched. By achieving these things we will continue to increase sales and profits.

PRICING

All prices are subject to change without notice. Orders will be invoiced at current prices on the date shipment is made. All prices are F.O.B. Green Leaf®, Inc.

TERMS

An invoice is a contract in which Green Leaf®, Inc. terms will prevail. Unless otherwise stated, payment terms are 2% 10 days net 30 days, (D.O.I.). Green Leaf® Inc. reserves the right to place a customer on credit hold if deemed necessary. Up to a 5% service charge will be added per month on all past due accounts.

ORDERING

Please order by Green Leaf's® part number.

US Orders: A \$10.00 handling charge will be added to all orders under \$50.00.

International Orders: A \$25.00 processing fee will be added to all orders under \$200.00.

NEW ACCOUNTS

Green Leaf®, Inc. welcomes all new accounts. Green Leaf® will provide a credit application for new customers to sign agreeing to our terms. When opening an account the customer agrees to pay invoices in 30 days, pay up to a 5% service charge monthly on any invoices 31 days or older, and to pay any and all collection agencies, attorney fees and/or court fees necessary to collect on the account.

SHIPPING

Please notify us with your shipping instructions. Freight, air, parcel post or UPS. If no instruction is given, we will send best way. Freight shipments should be specified, via truck or rail, with line preference. A handling/service charge of \$2.00 will be added to all invoices.

SAME DAY SHIPMENTS

Same day shipments will incur a service charge of \$10.00 or 5%, whichever is greater.

WEIGHT VARIANCE

To control the cost of processing your orders, Green Leaf® uses electronic counting scales. It is our policy to have each scale certified for accuracy on a schedule recommended by the scale manufacturer. Electronic scales have an accuracy range that is acceptable by most of our customers. If your policy does not allow for a small overage/underage, please contact our marketing department and advise them that you require 100% accuracy of all quantities. Your account will be marked as hand count only. There is a charge of plus 5% of order value for all orders processed in this manner.

RETURNED GOODS POLICY

Returns must be received within 30 days from shipment and must be approved by Green Leaf®, Inc. A document with our return authorization number (RGA Number) and ship to address will be faxed or mailed to the customer. Any goods returned that do not have this document clearly attached to the outside of the carton will be refused. All returns must be freight prepaid. A 20% minimum restocking fee will be assessed to all returns. Returns will only be accepted if the products are in new and original condition, and contain no markings or labels other than Green Leaf®.

SHORTAGES

Claims must be made within 30 days after receipt of shipment; otherwise order will be considered shipped as ordered.

LOSS OR DAMAGE

In order to expedite your shipment to its destination in good condition, all orders are packed and shipped with care. Green Leaf®, Inc. assumes no responsibility for items lost or damaged in transit. Claims will be made with carriers immediately. The purchaser is responsible for claims on freight collect shipments.

GUARANTEE

Green Leaf®, Inc. warrants all merchandise to be as represented in our catalog. We will replace or make satisfactory adjustment if found otherwise.

USE OF PRODUCTS

Products manufactured by Green Leaf® and illustrated within this catalog are produced using resins that are prime and certifiable in grade. The chemical resistance & physical properties of these resins are available from Green Leaf®'s engineering department. Improper use of these products could result in environmental spills, serious injury or death.

MATERIALS

As stated, Green Leaf, Inc.'s stock fittings are always manufactured using quality prime resins; however, in order to insure that we continue to provide the best value to our customers, we reserve the right to change specific grades and/or manufacturers of resin without notice. Please keep this in mind when specifying our stock fittings for use in your applications. Due to the infinite end use possibilities of our products, the customer is responsible for determining the suitability of our products for their application. Data sheets indicating the manufacturer, grade, and properties of current production materials are available and may be requested at anytime. Should your application require a specific material, please contact our sales department for a custom quotation.

ISO Certified Company



GREENLEAF
INCORPORATED

THE FLUID FLOW EXPERTS

Address:

9490 N. Baldwin St. • Fontanet, IN 47851

Web: green-leaf.us

Phone: 800.654.9808

Fax: 812.877.4278